

Schnitt A - A Bestehender Energievernichter SE Hydropower 1:25  
Sezione A - A Dissipatore esistente SE Hydropower 1:25

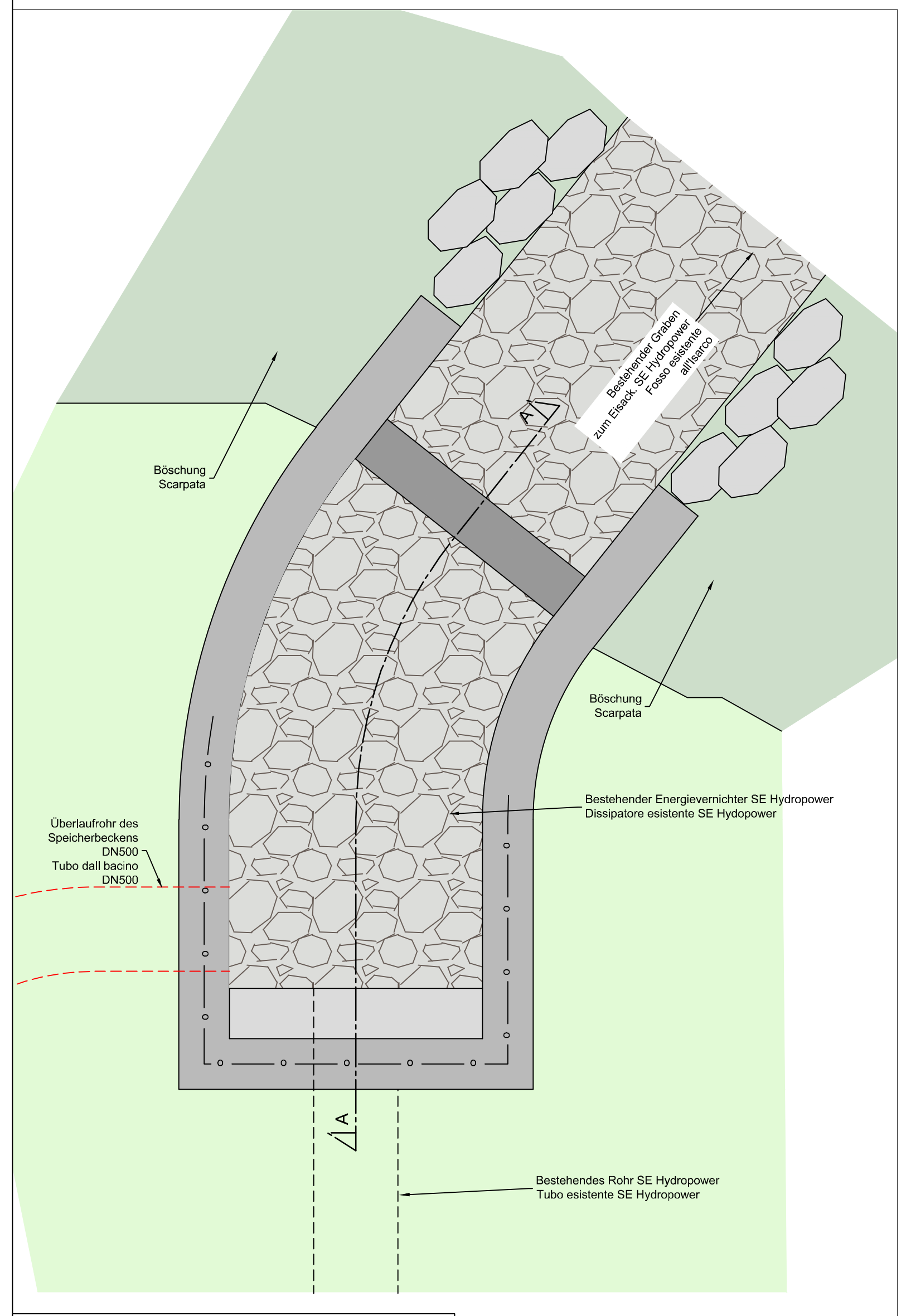

Überlaufbauwerk - Bewehrung 1:50  
Opera di sfiatore - armatura 1:50

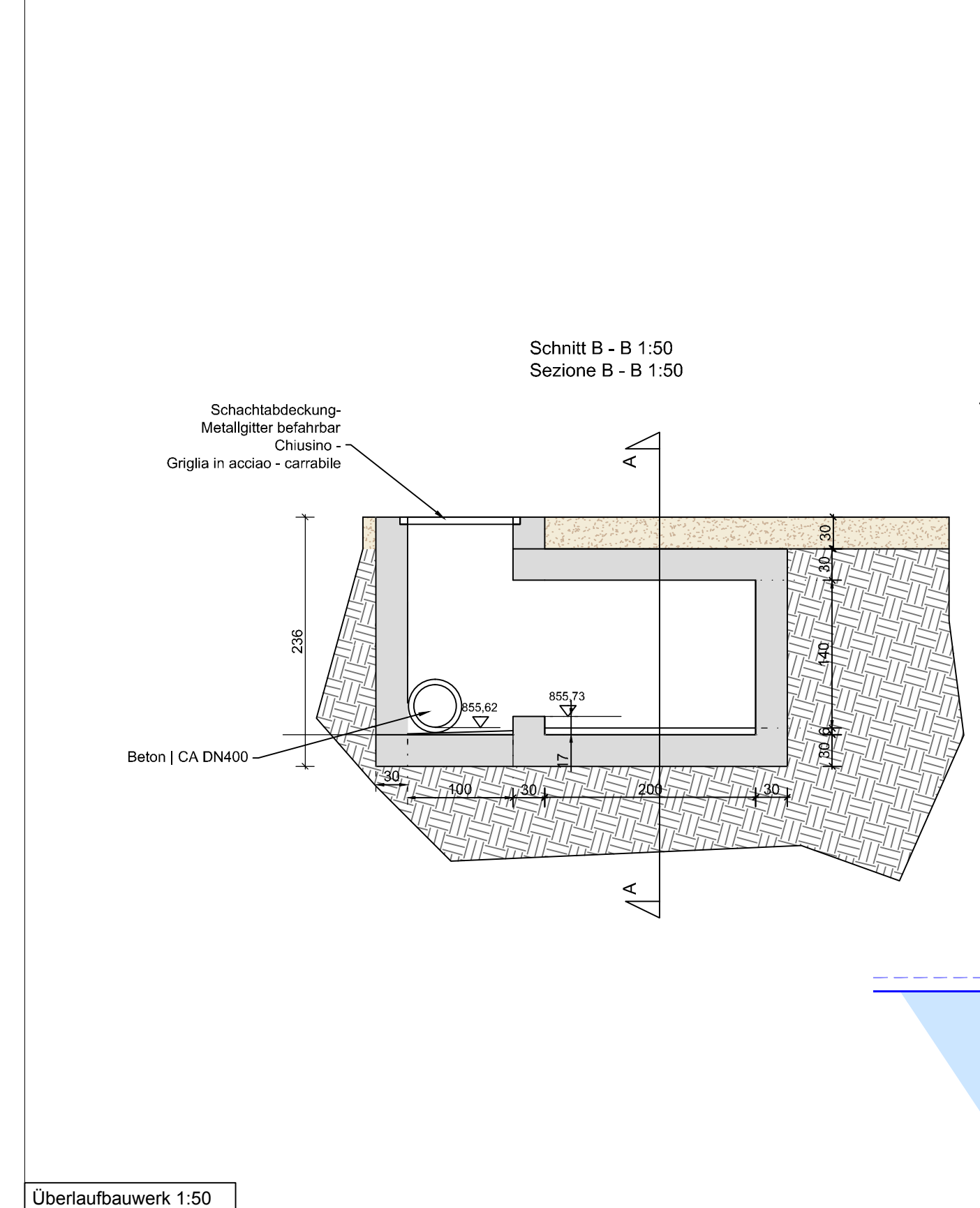

Überlaufbauwerk 1:50  
Opera di sfiatore 1:50

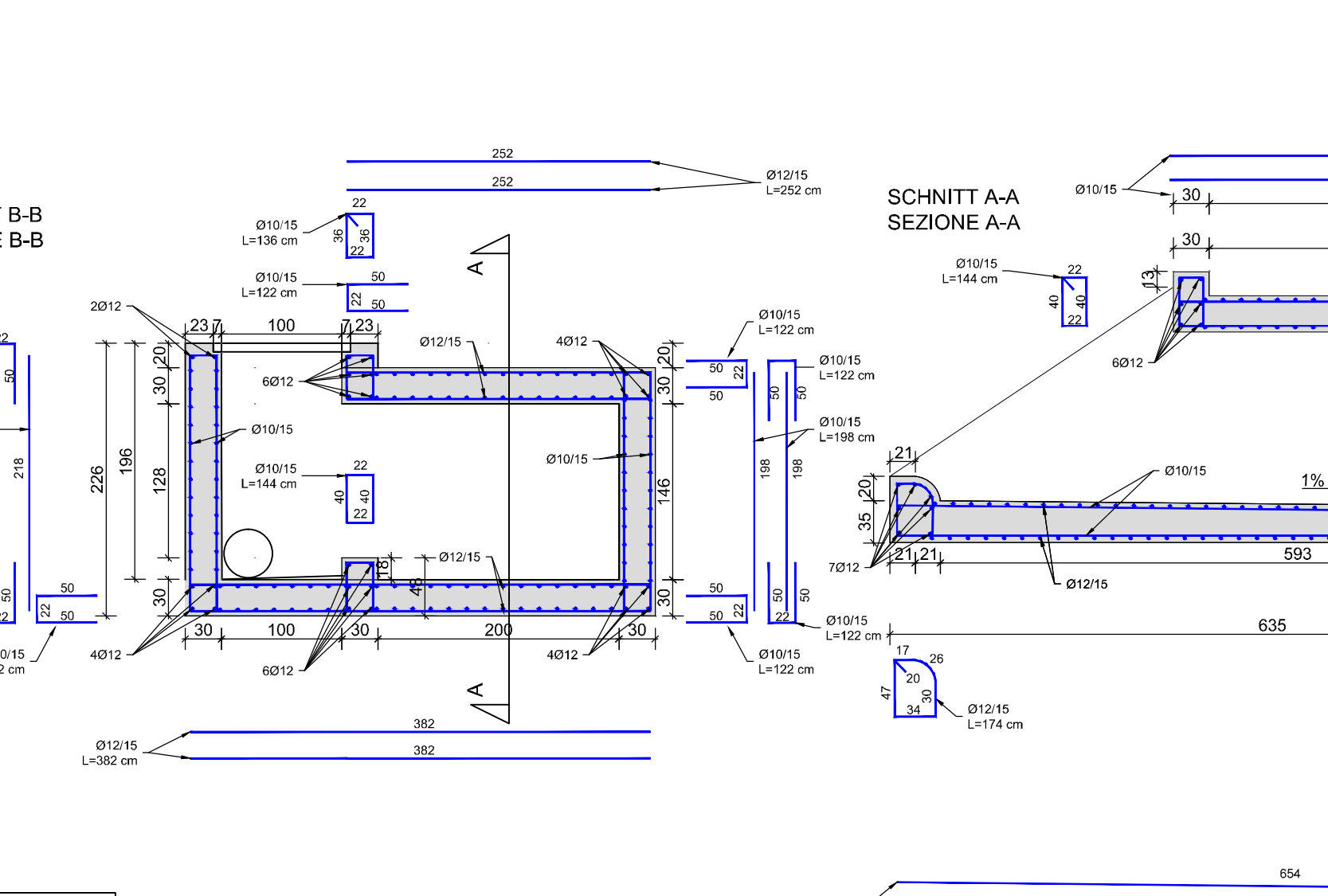
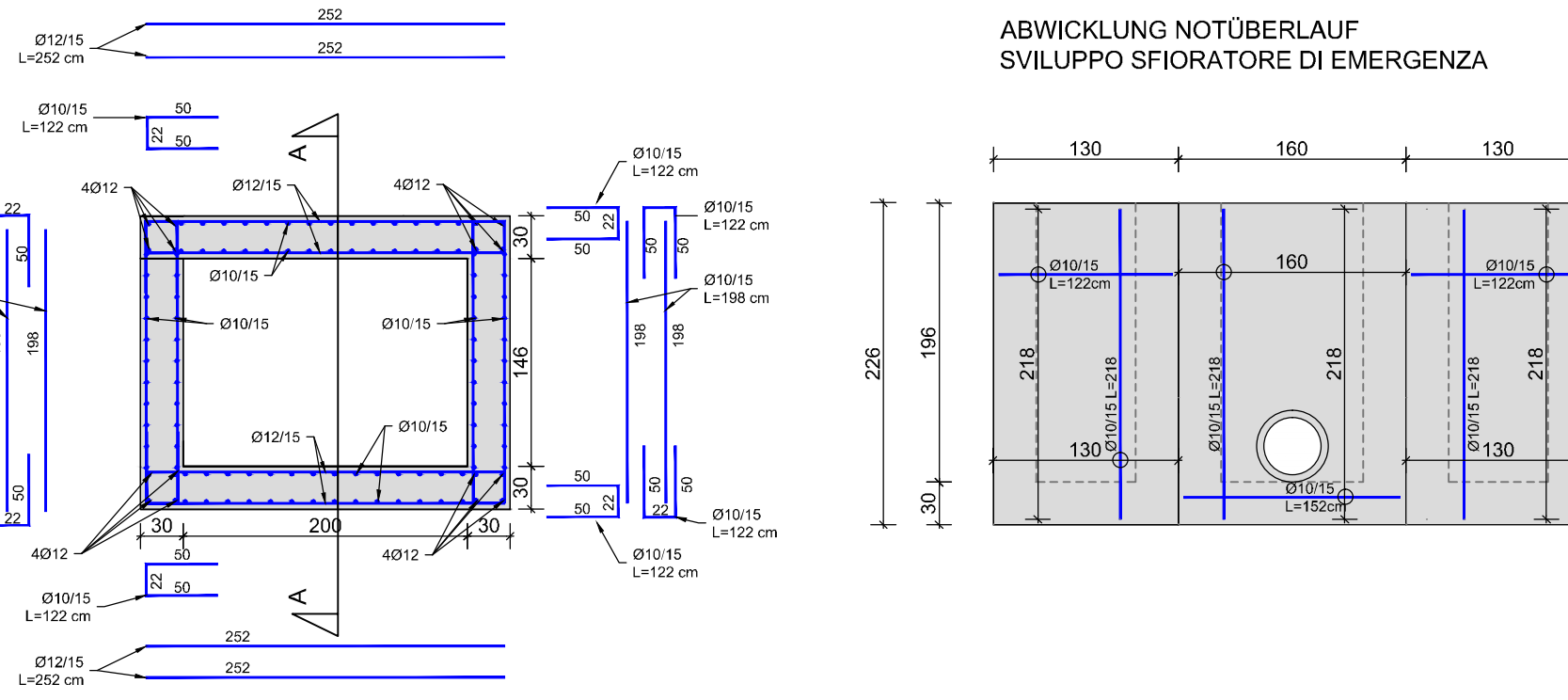
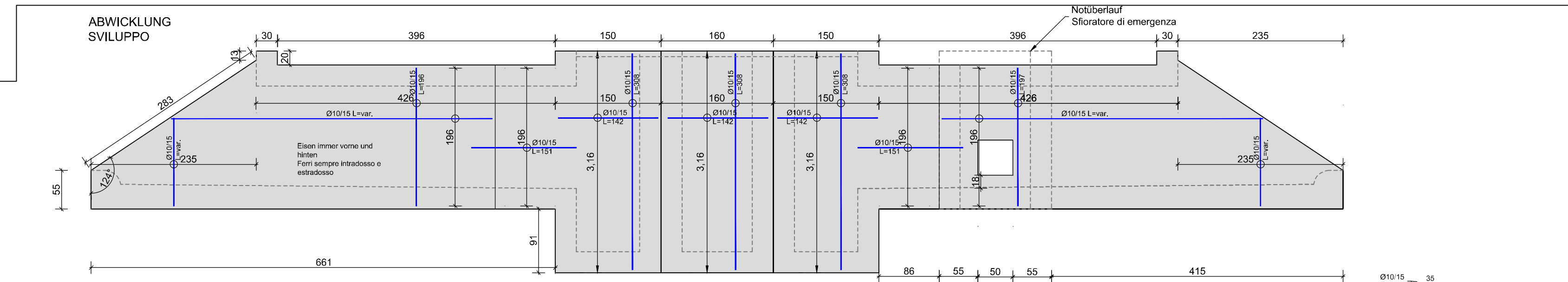

Überlaufbauwerk - Bewehrung 1:50  
Opera di sfiatore - armatura 1:50

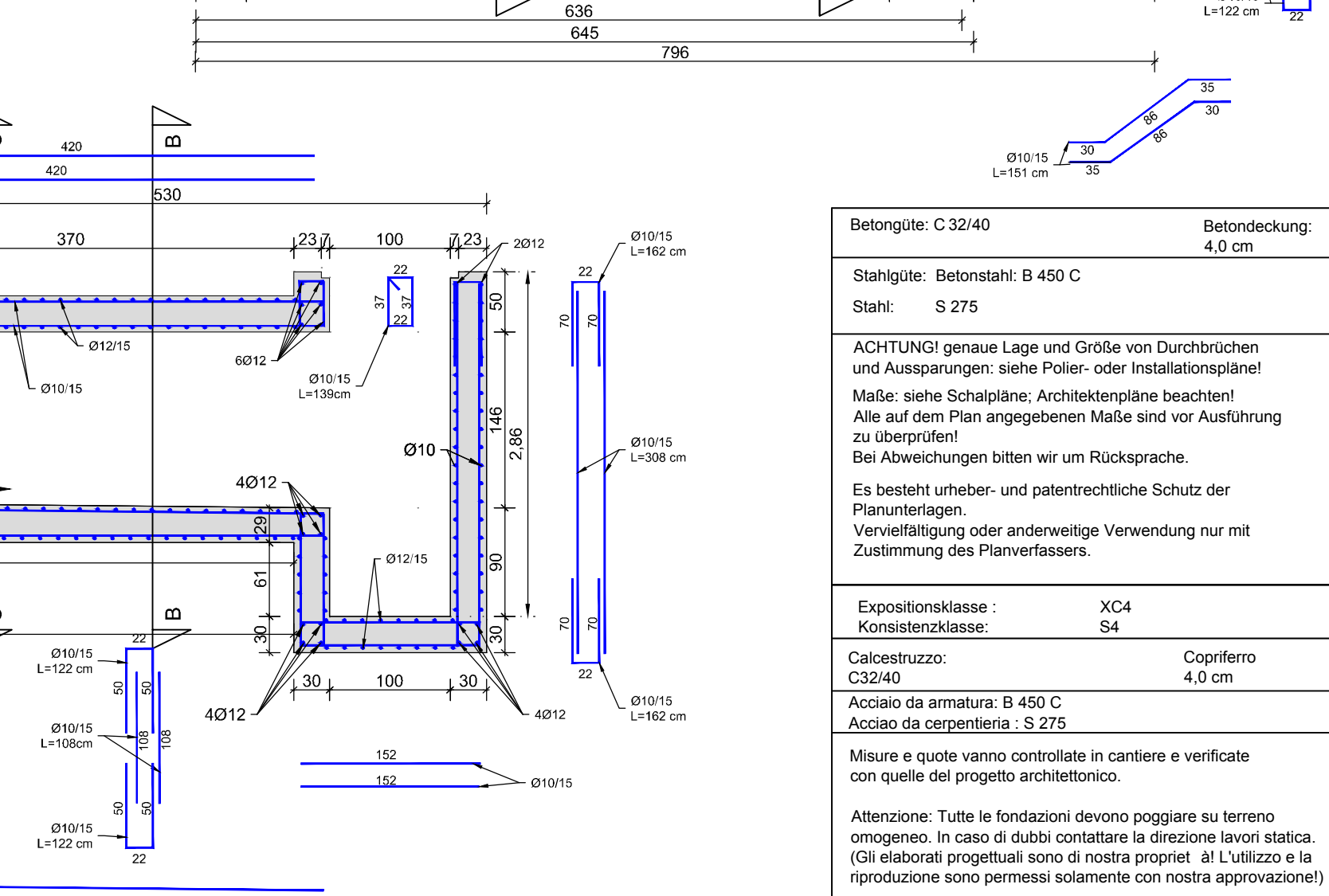
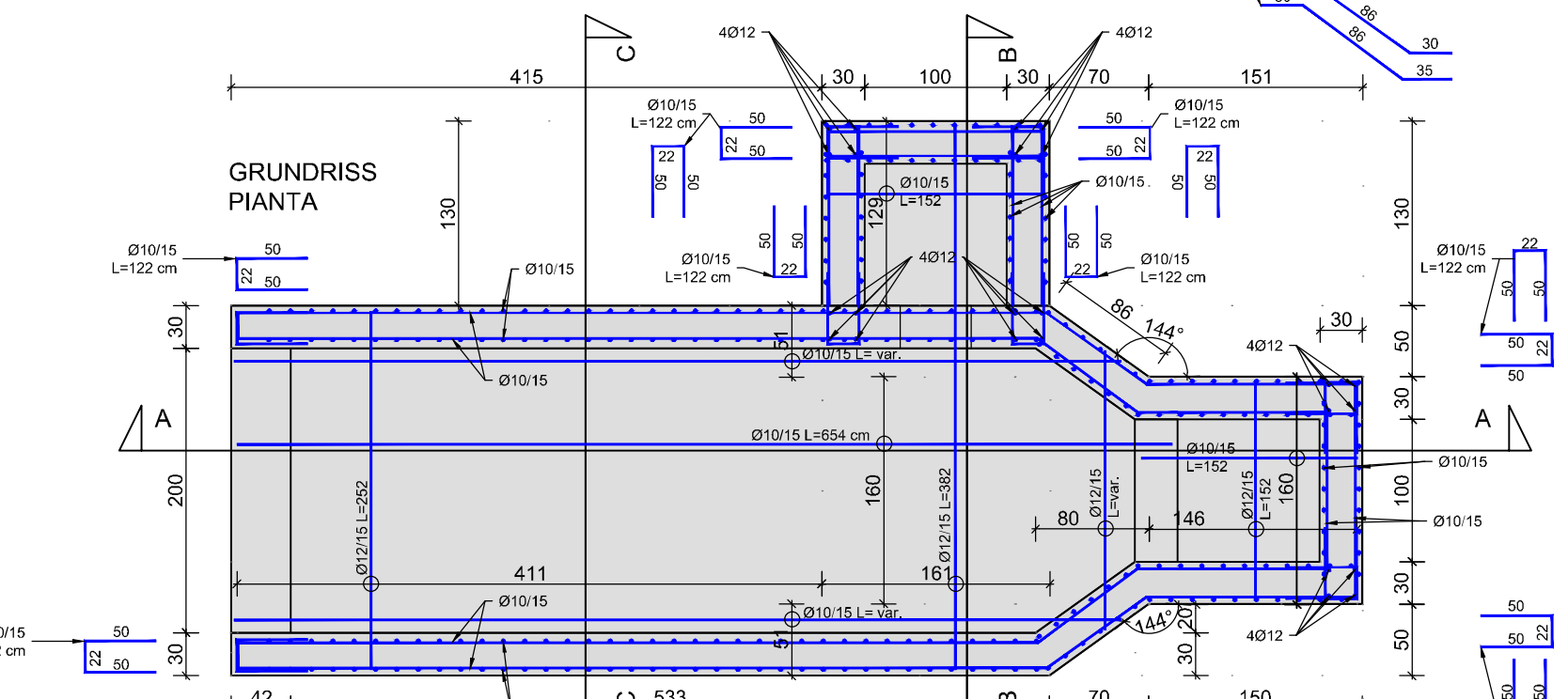
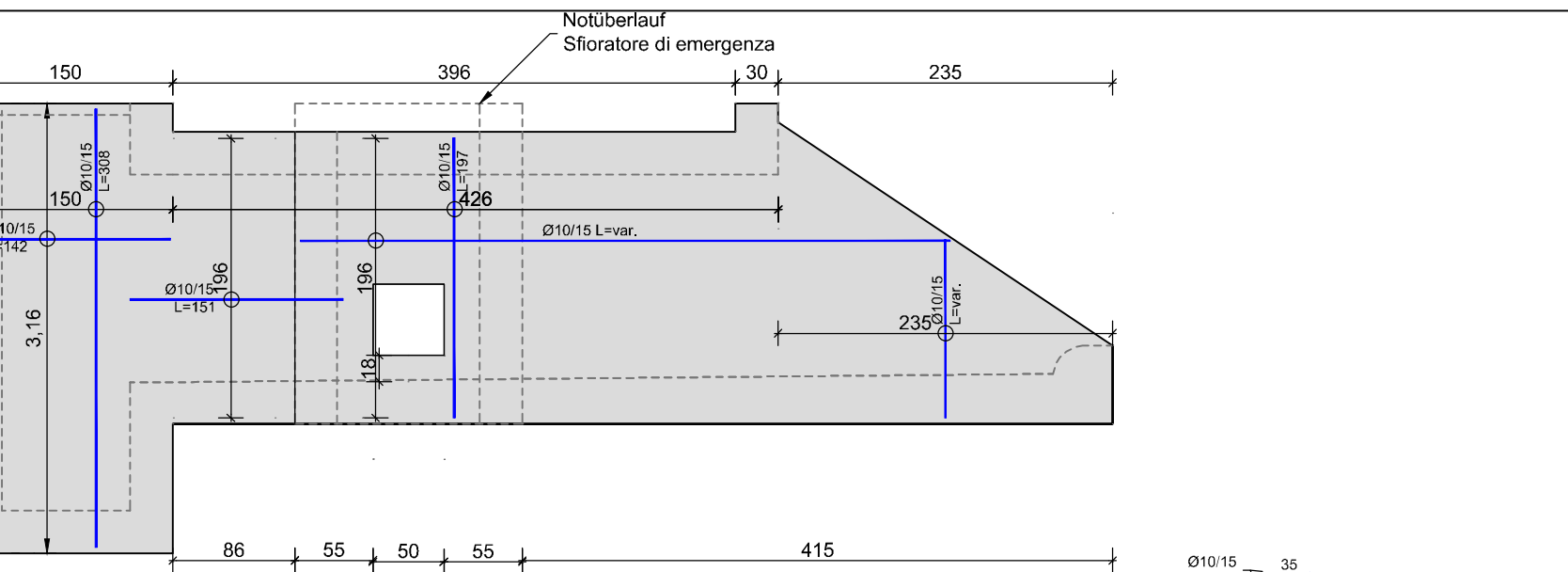
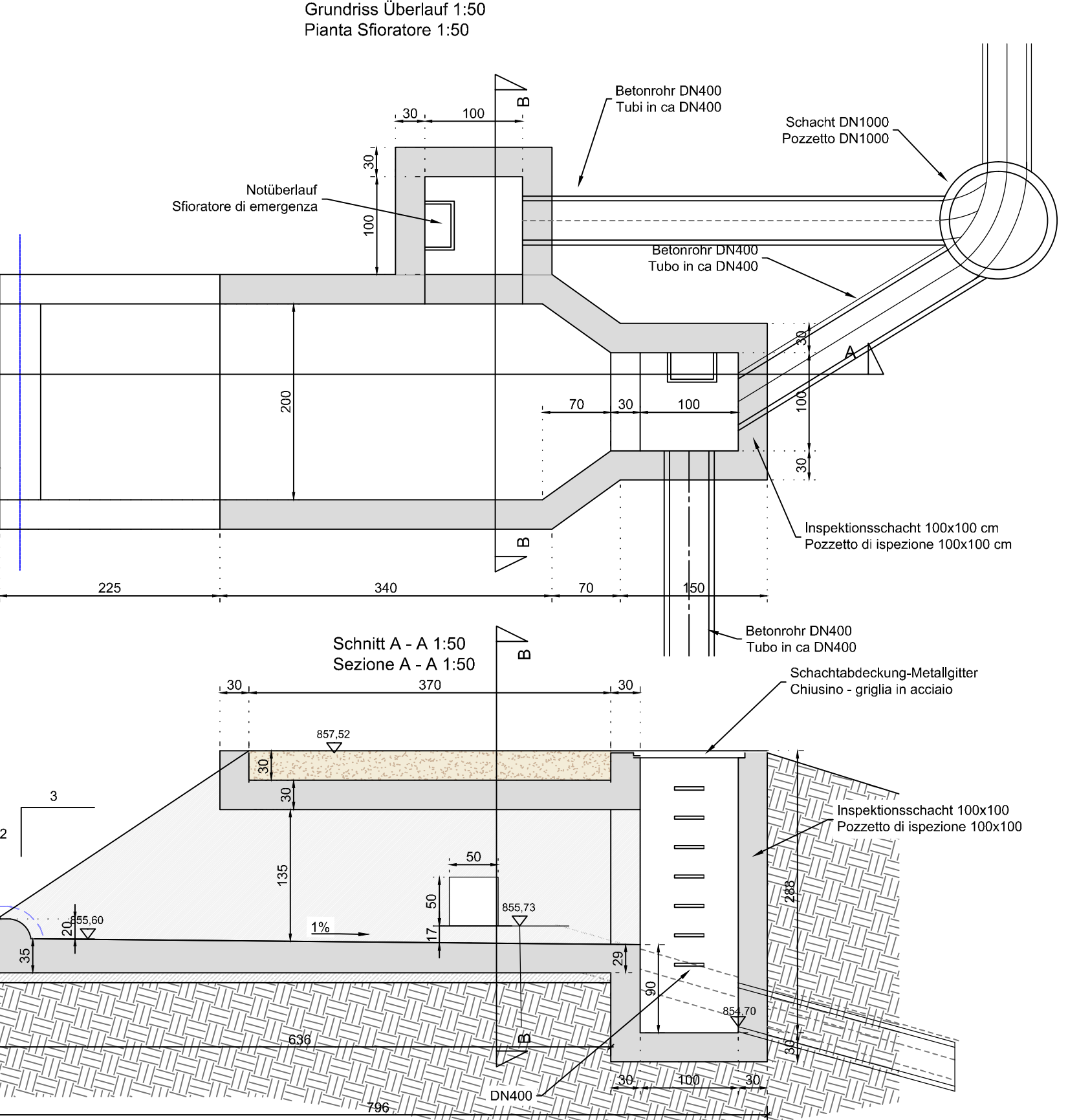

Überlaufbauwerk - Bewehrung 1:50  
Opera di sfiatore - armatura 1:50

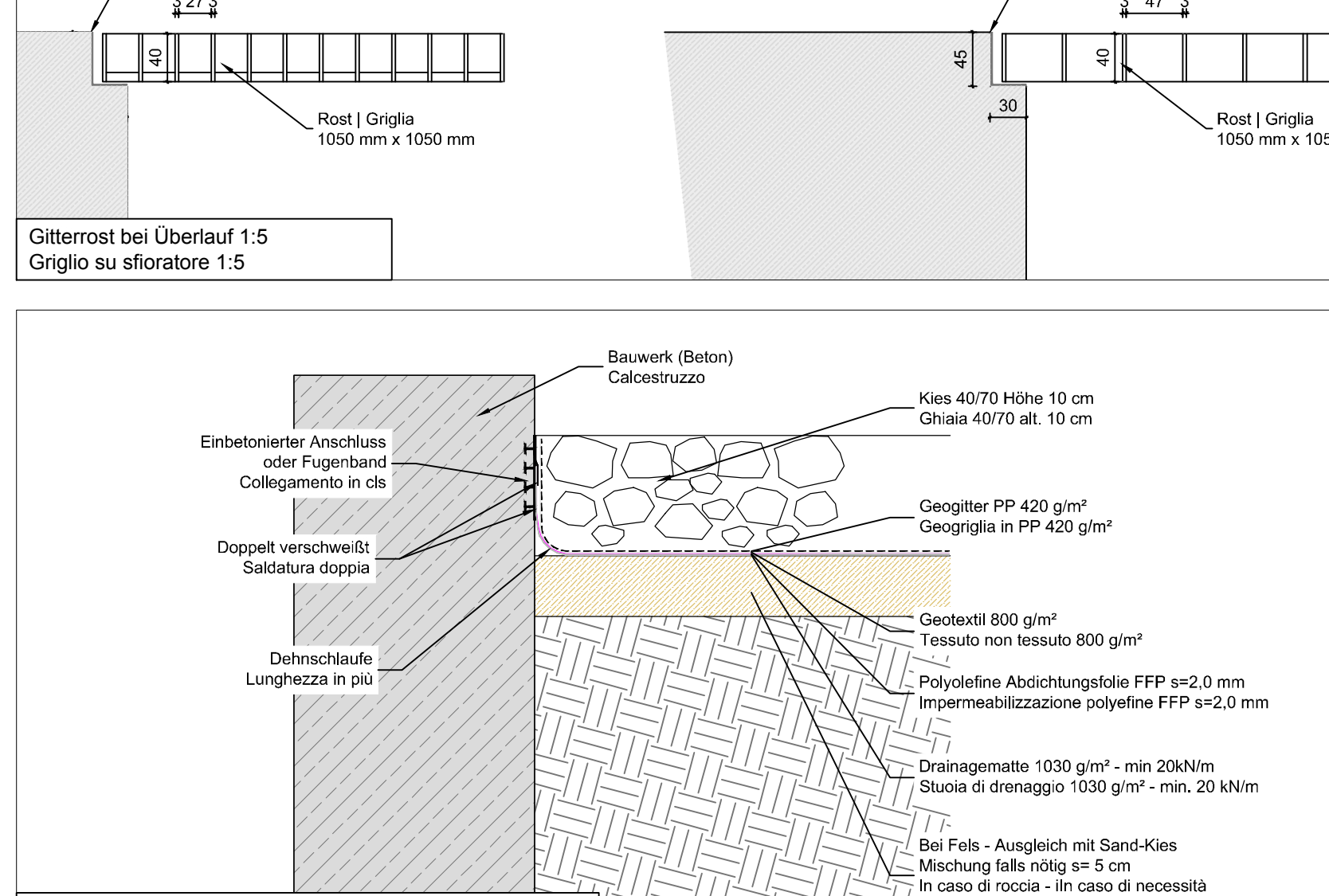
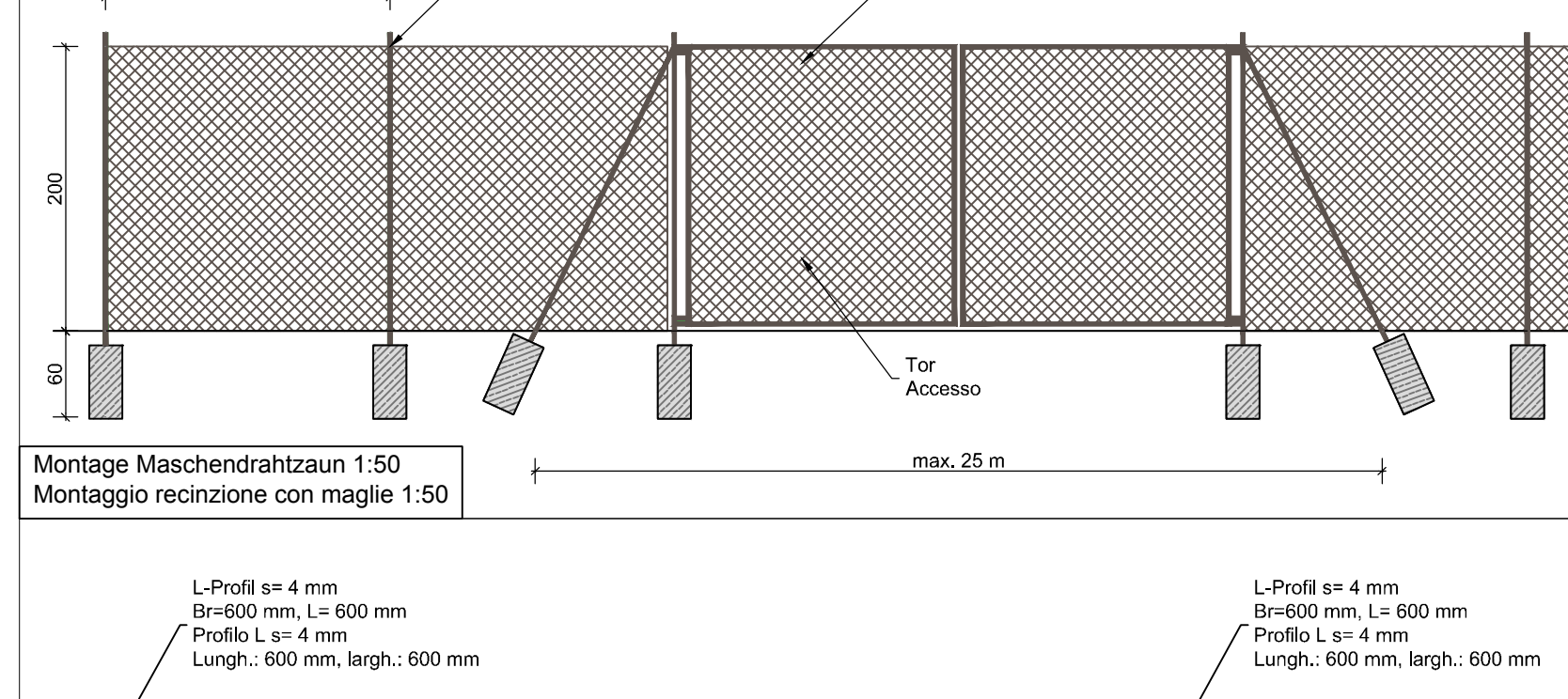
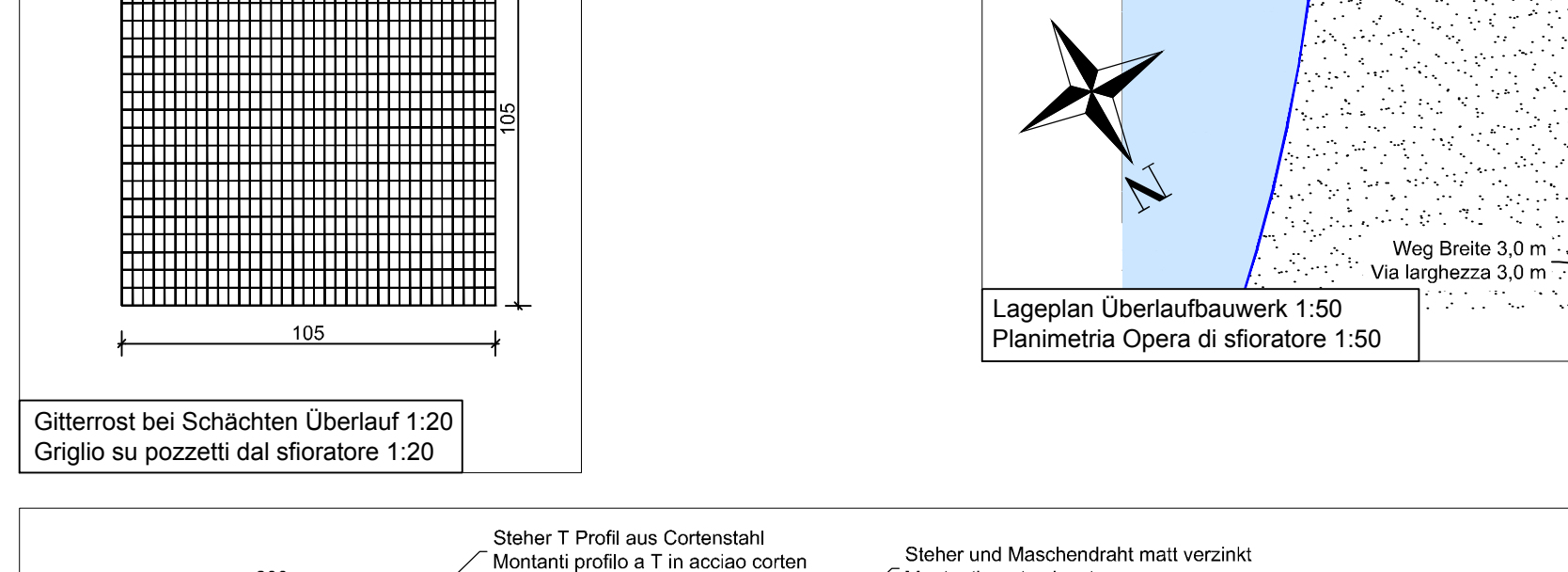
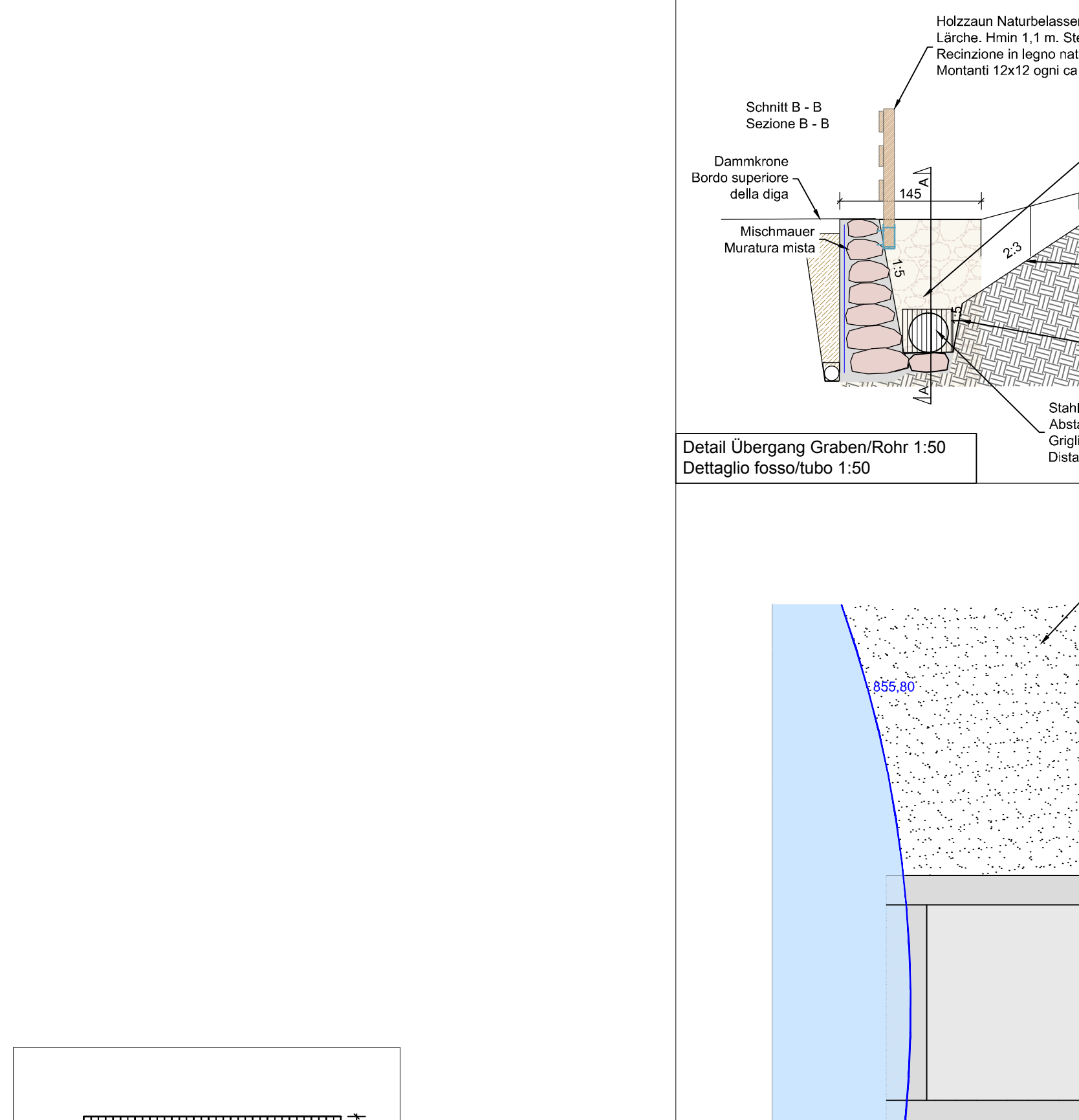

Überlaufbauwerk - Bewehrung 1:50  
Opera di sfiatore - armatura 1:50

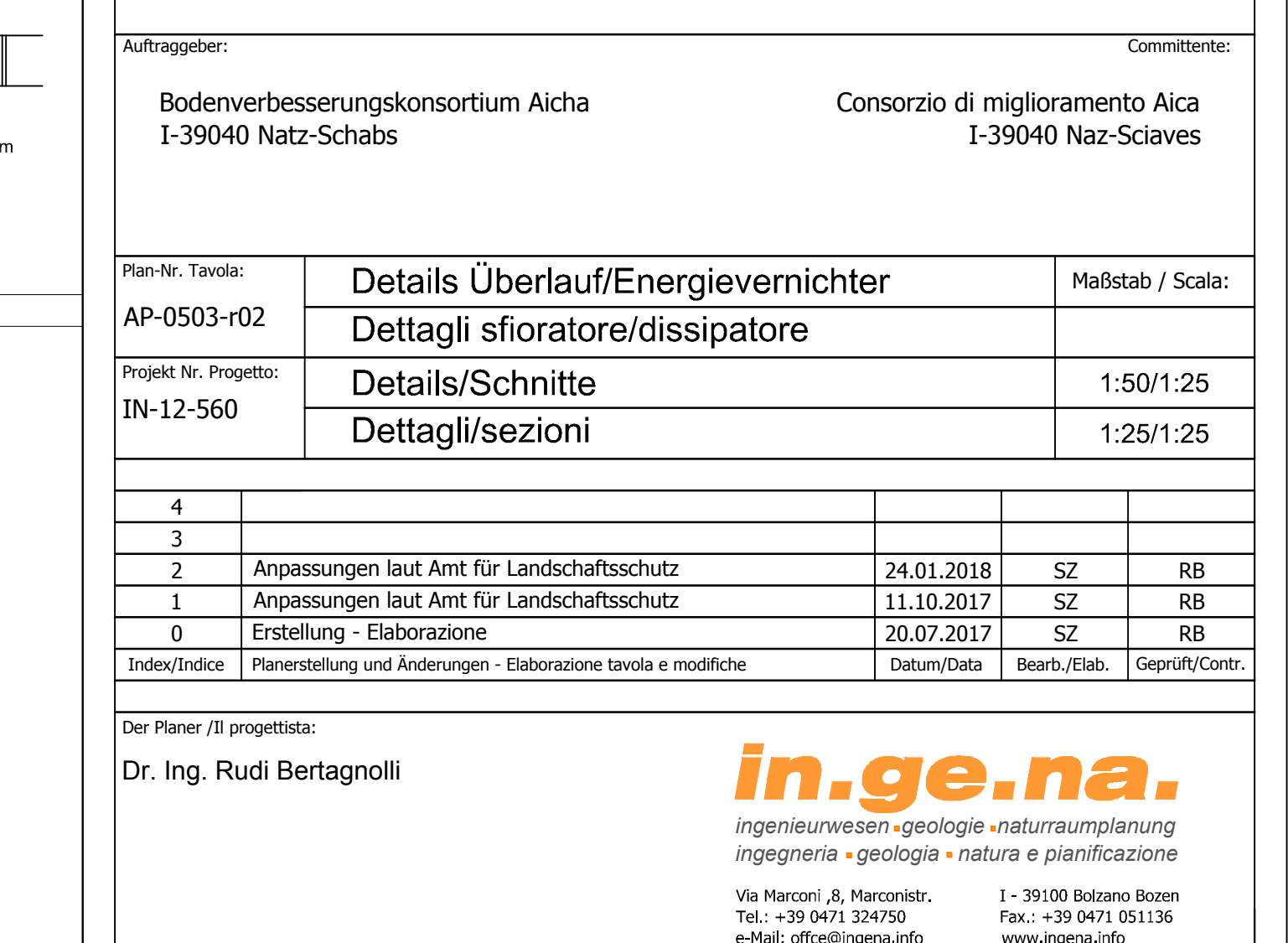
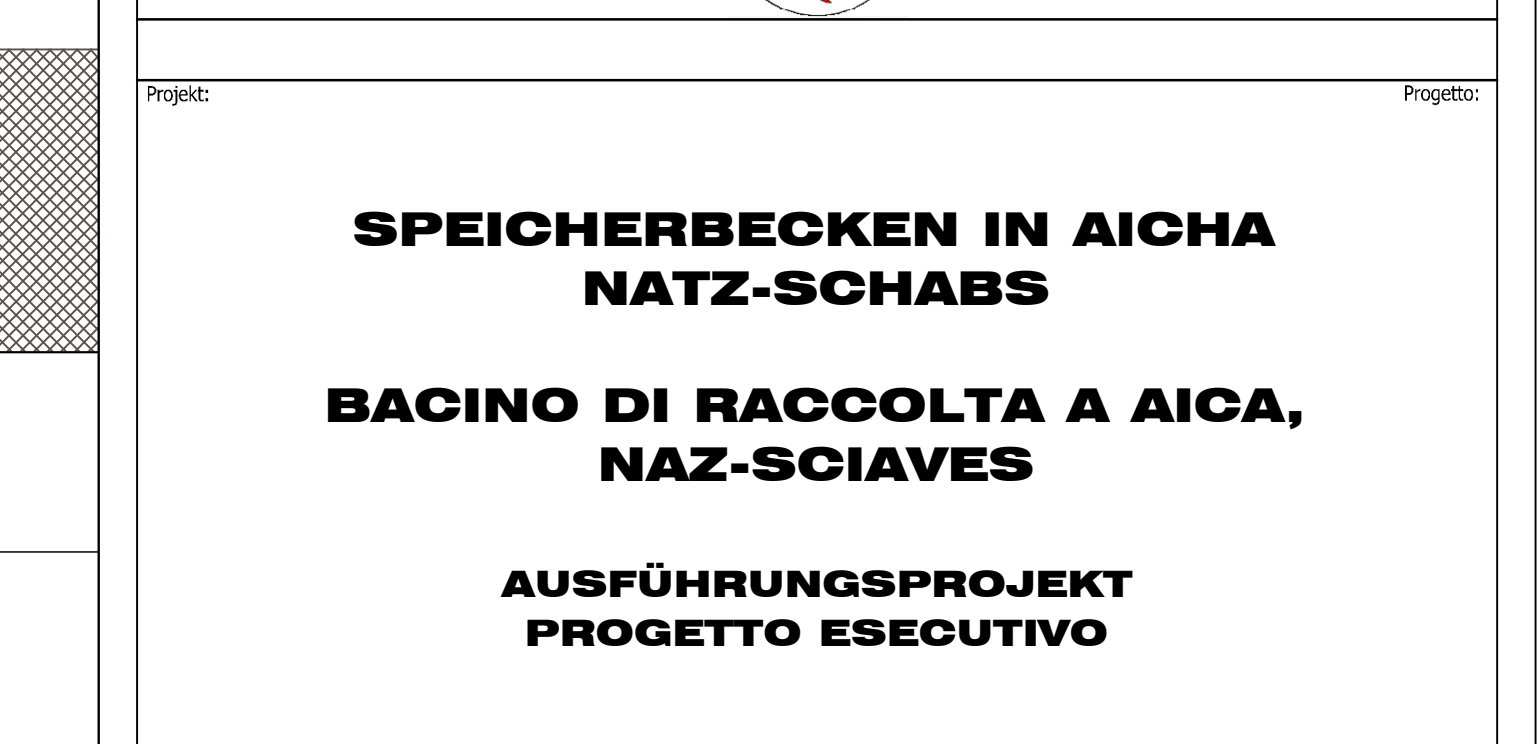
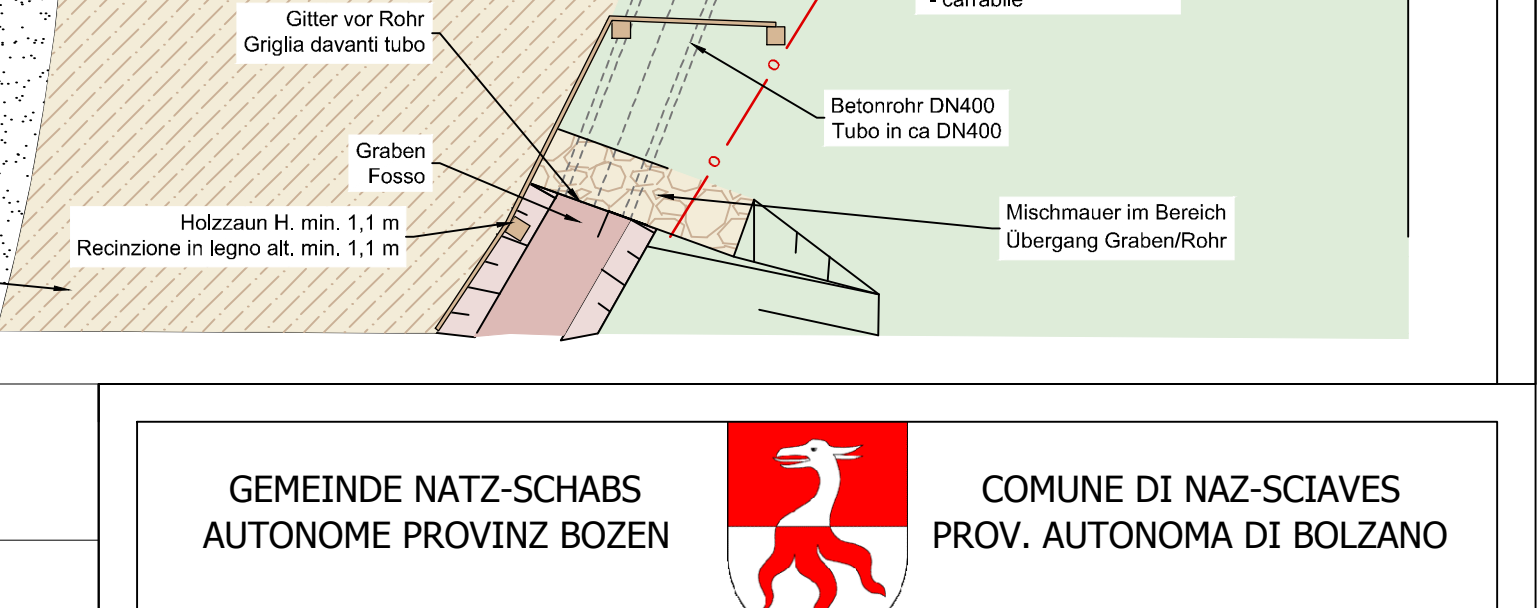
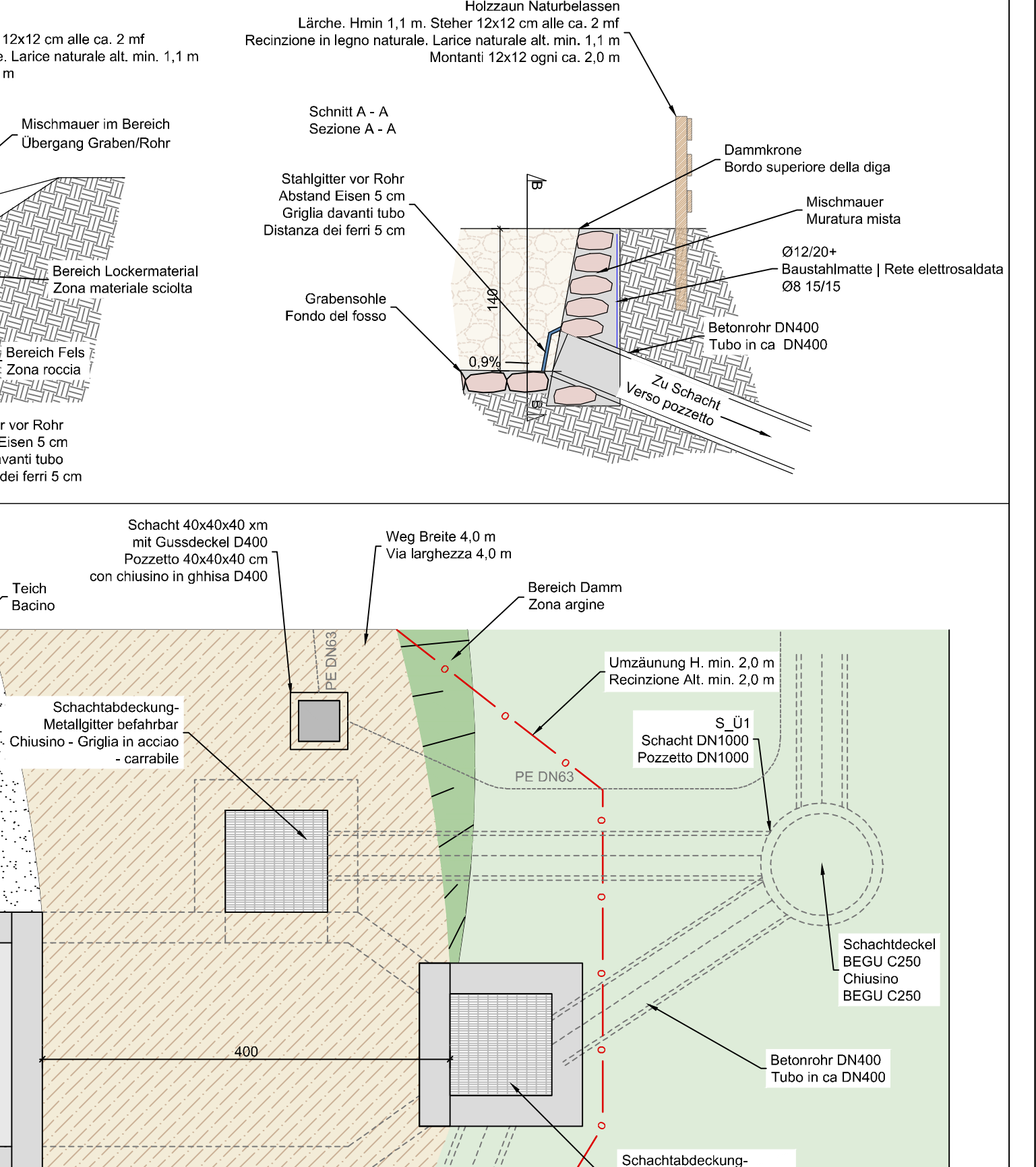

Überlaufbauwerk - Bewehrung 1:50  
Opera di sfiatore - armatura 1:50

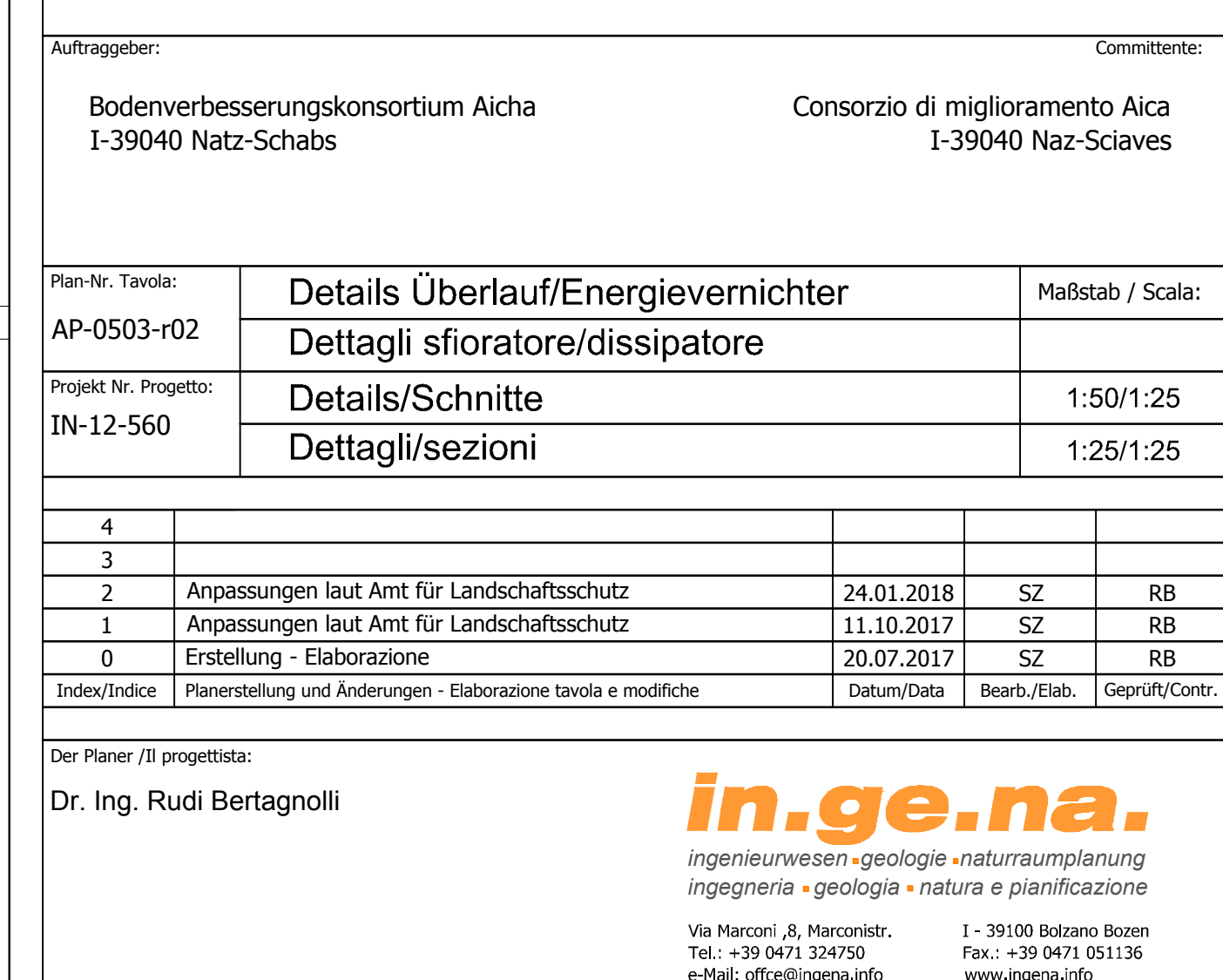
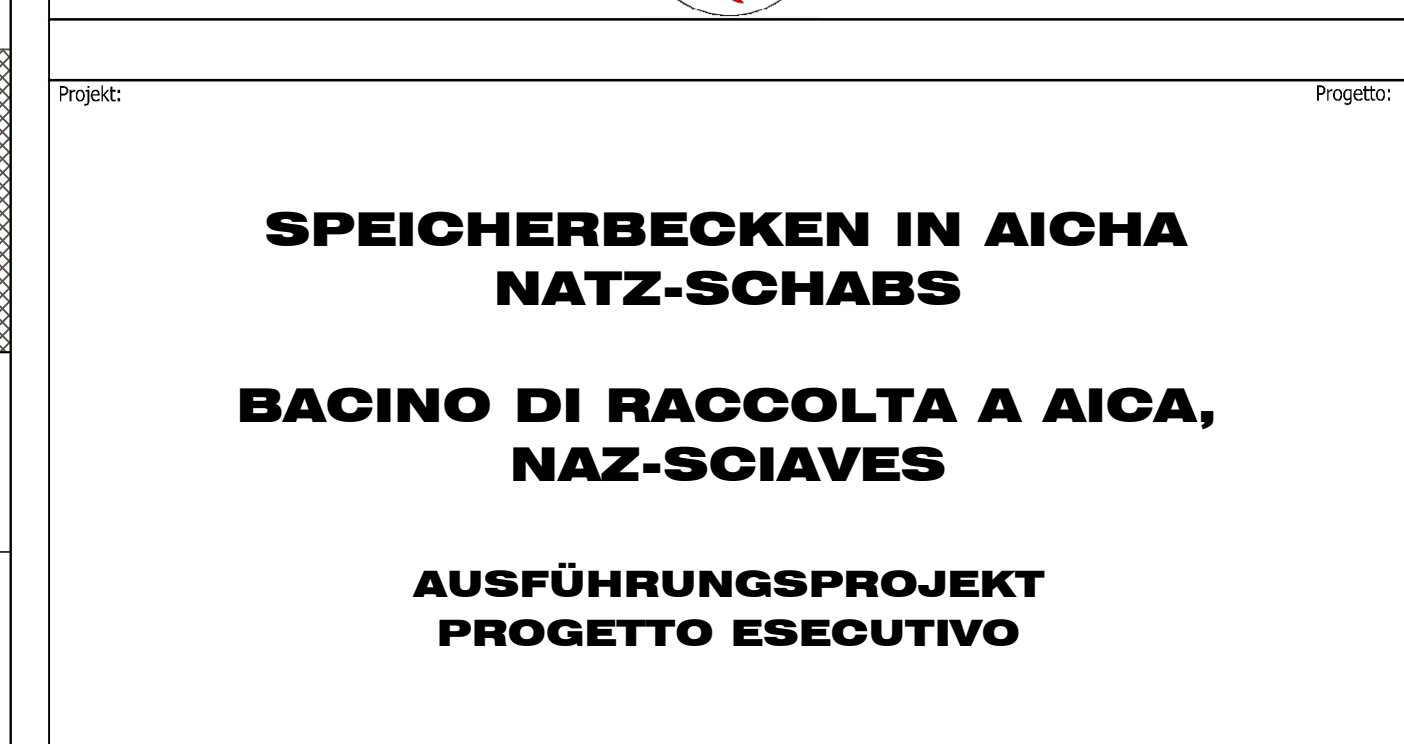
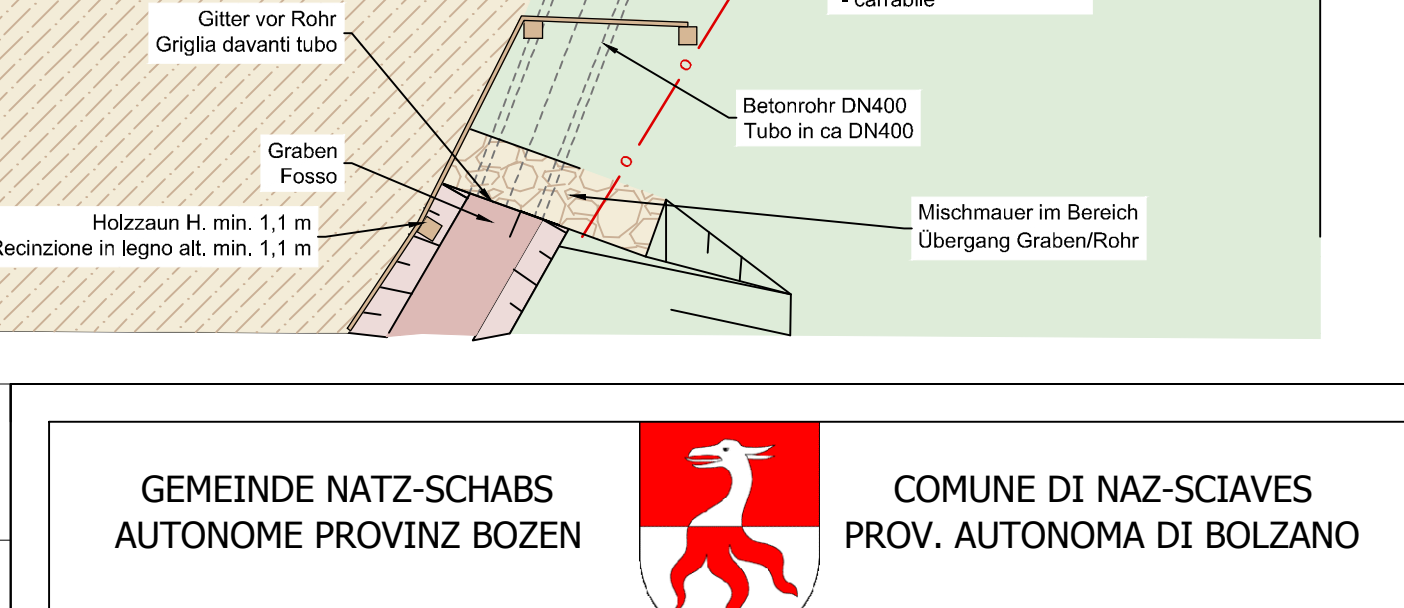
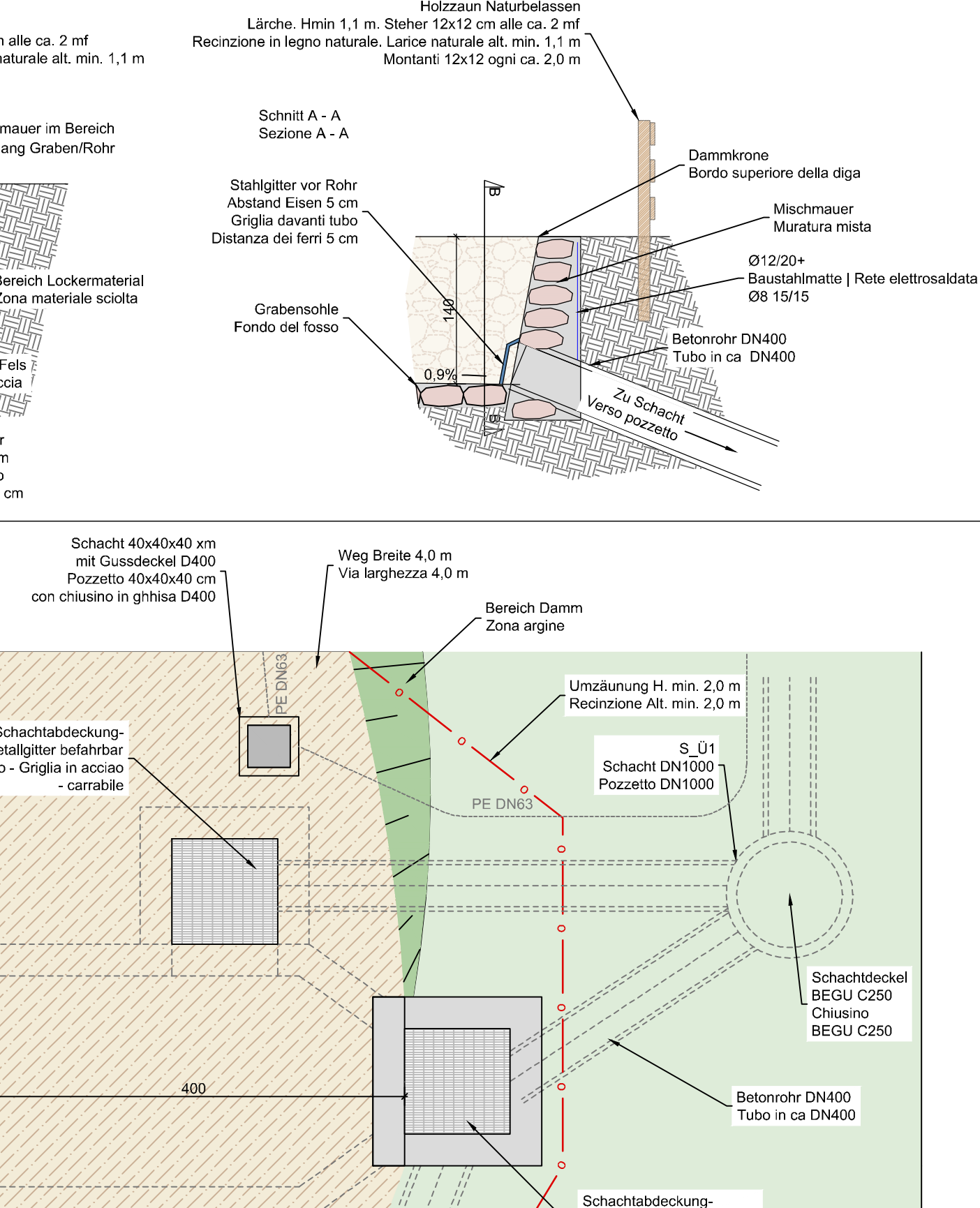

Überlaufbauwerk - Bewehrung 1:50  
Opera di sfiatore - armatura 1:50

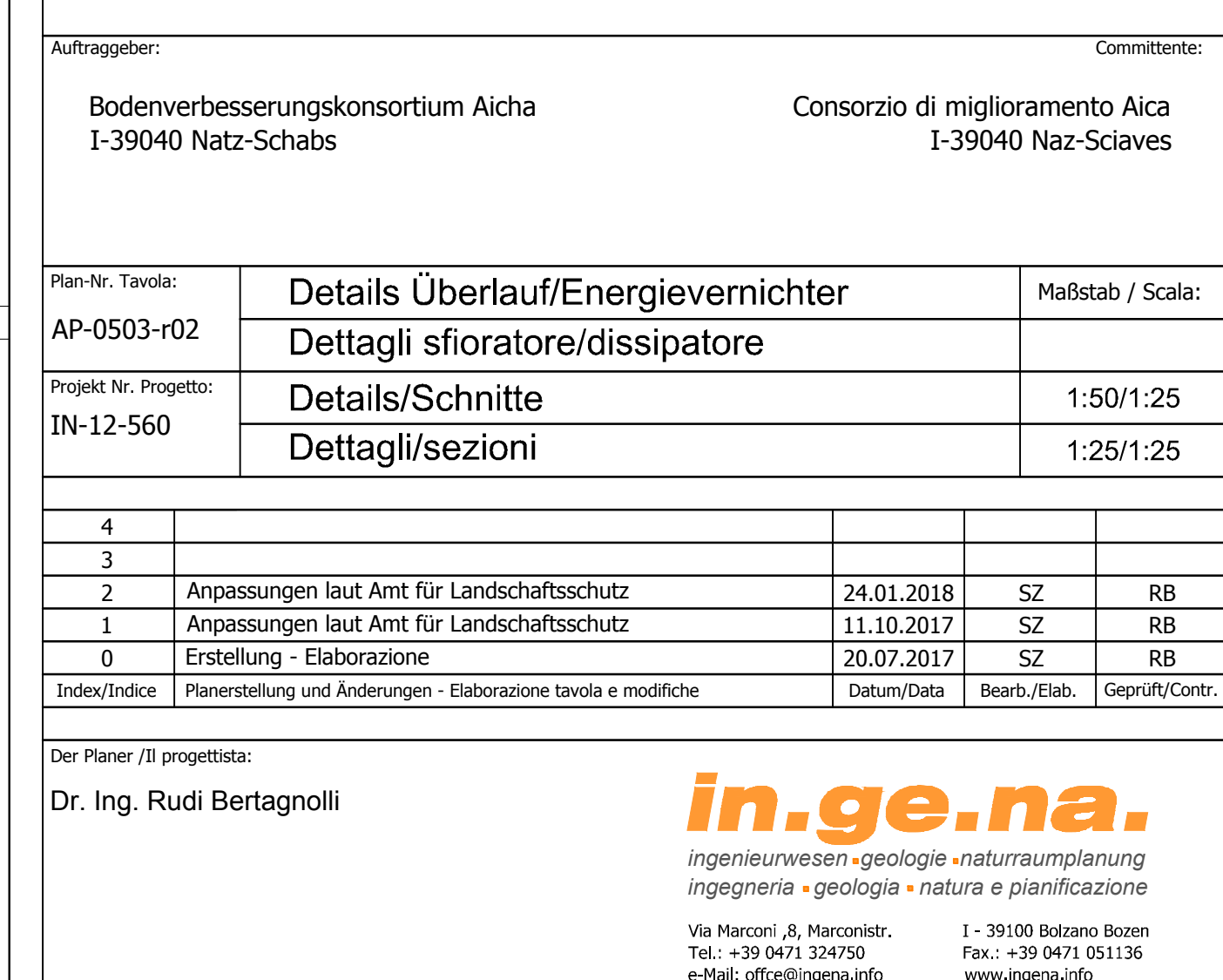
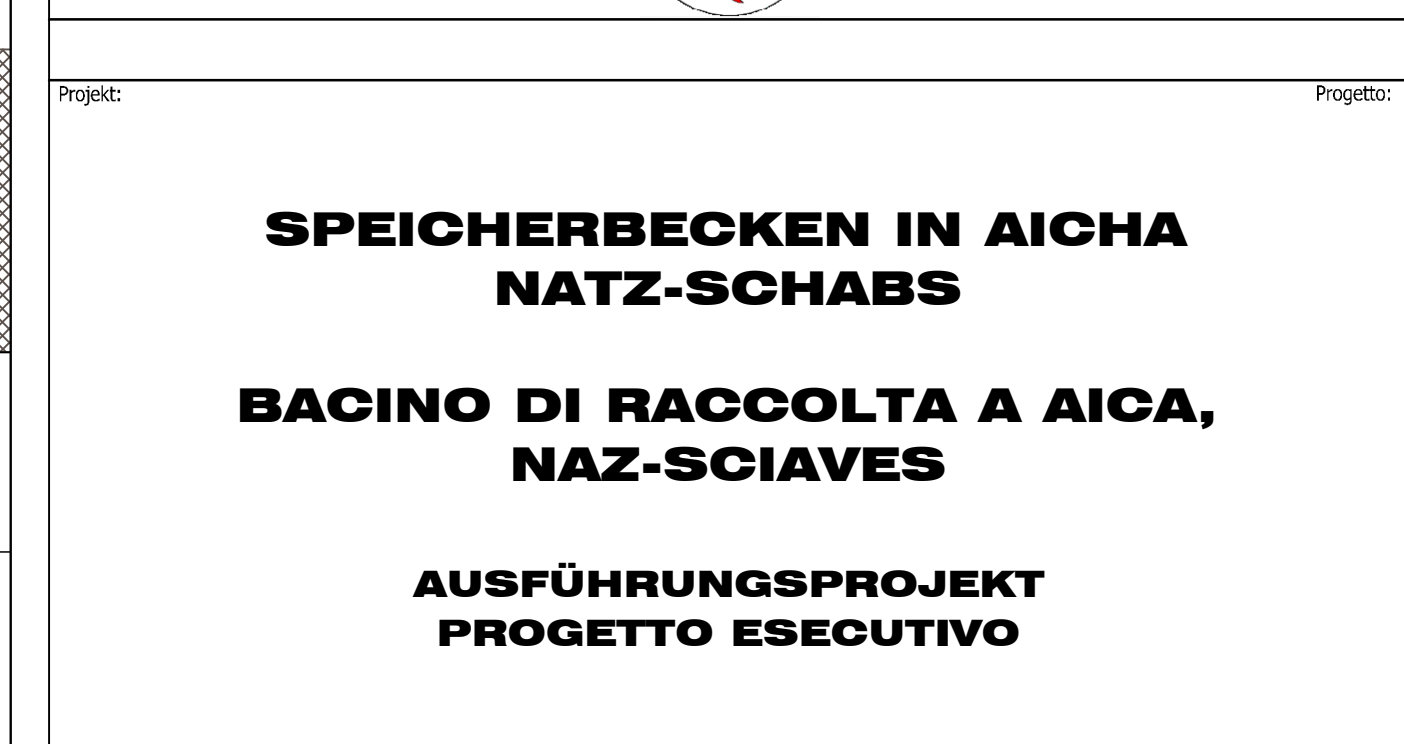
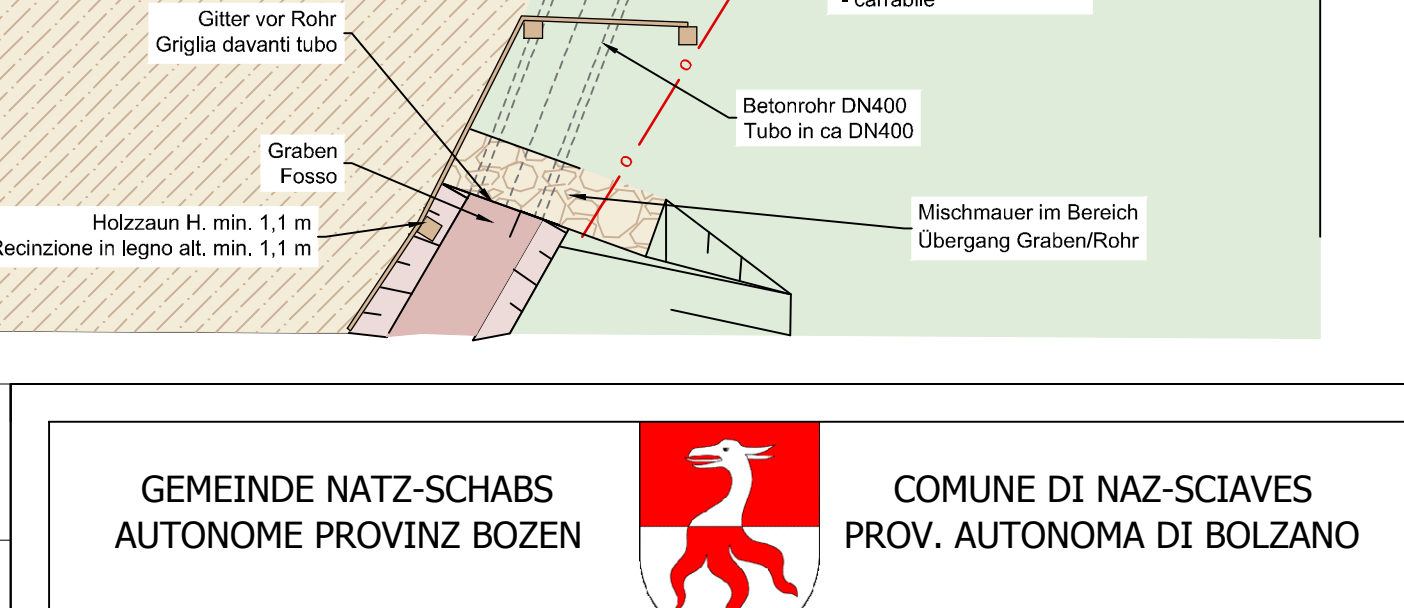
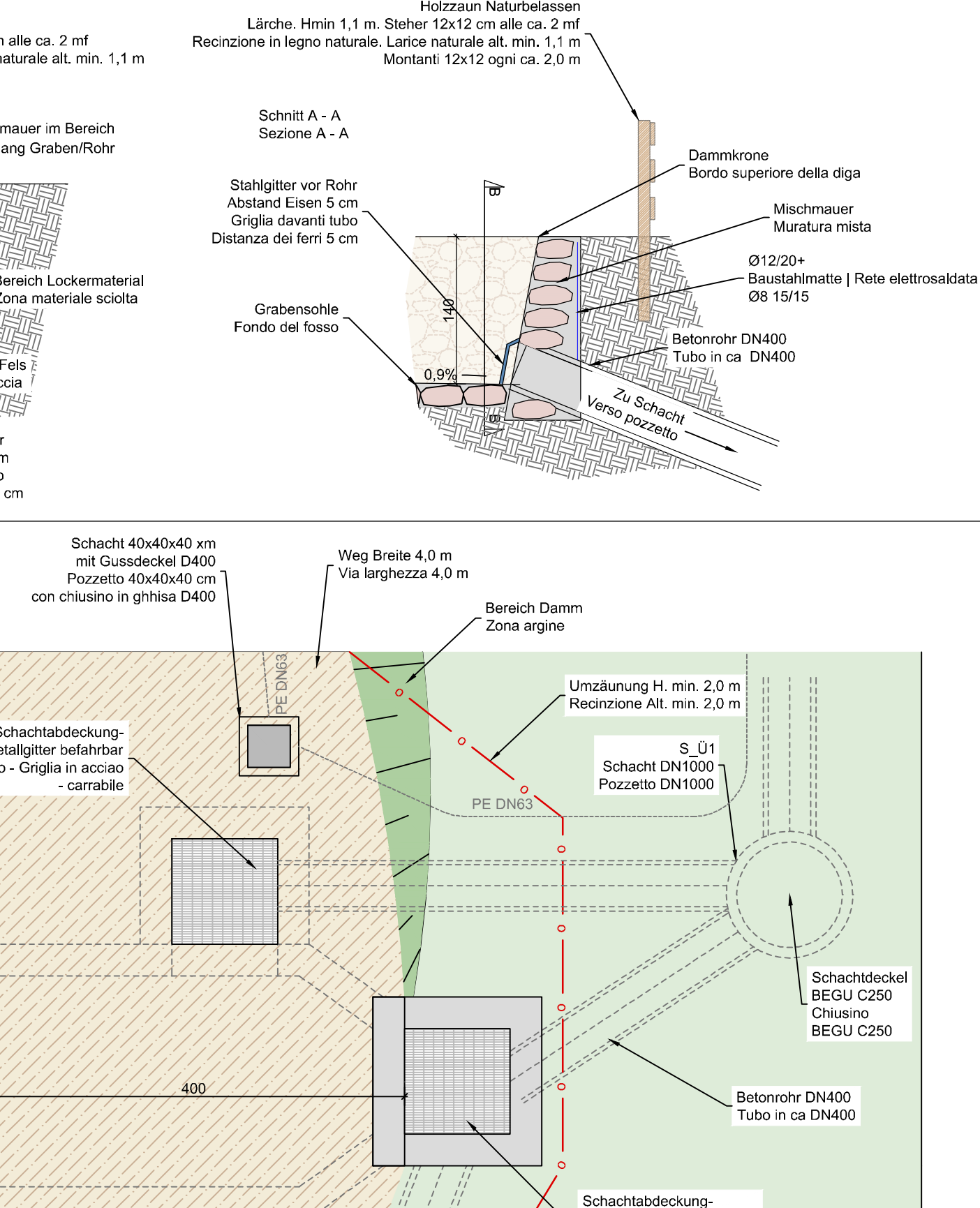

Überlaufbauwerk - Bewehrung 1:50  
Opera di sfiatore - armatura 1:50

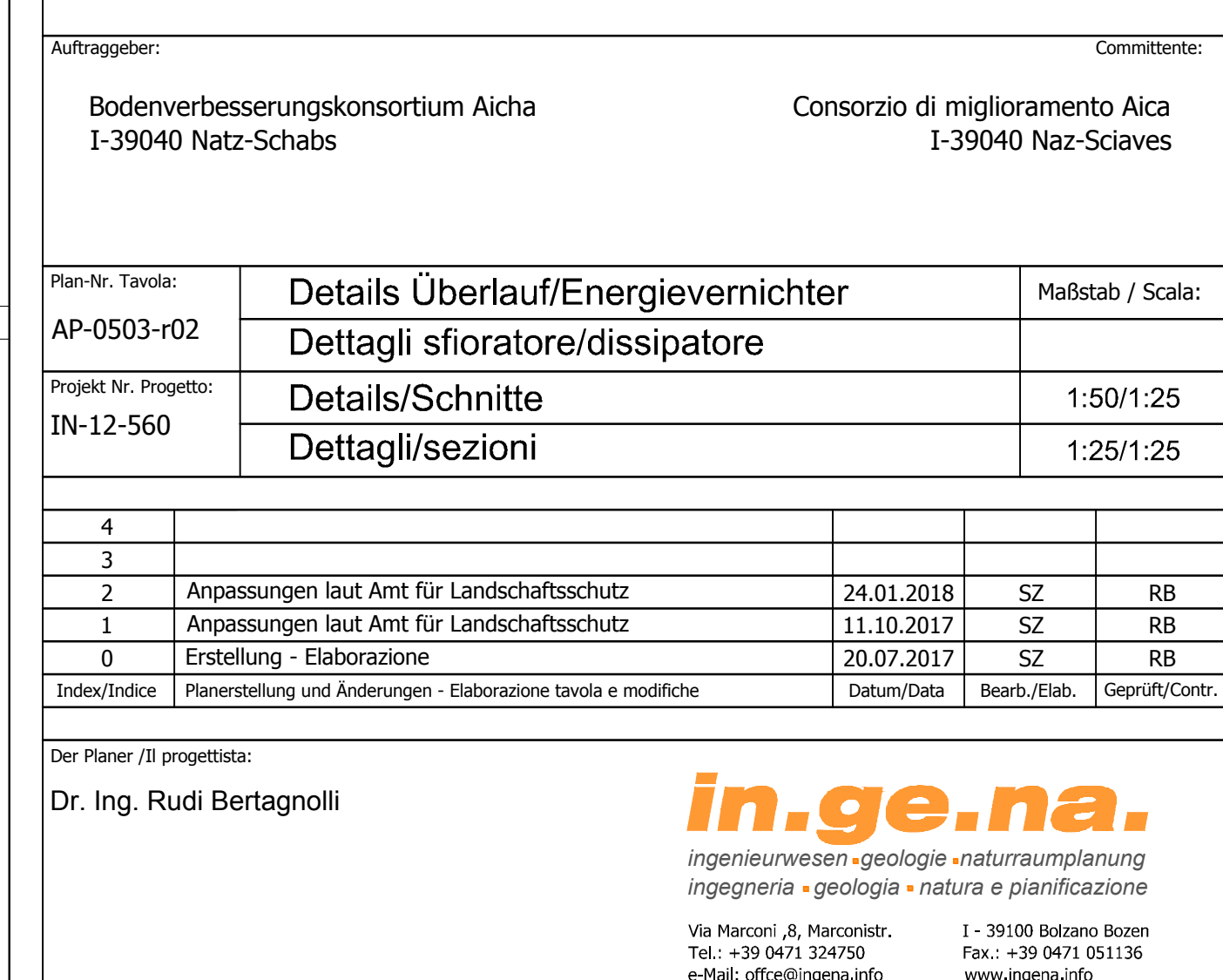
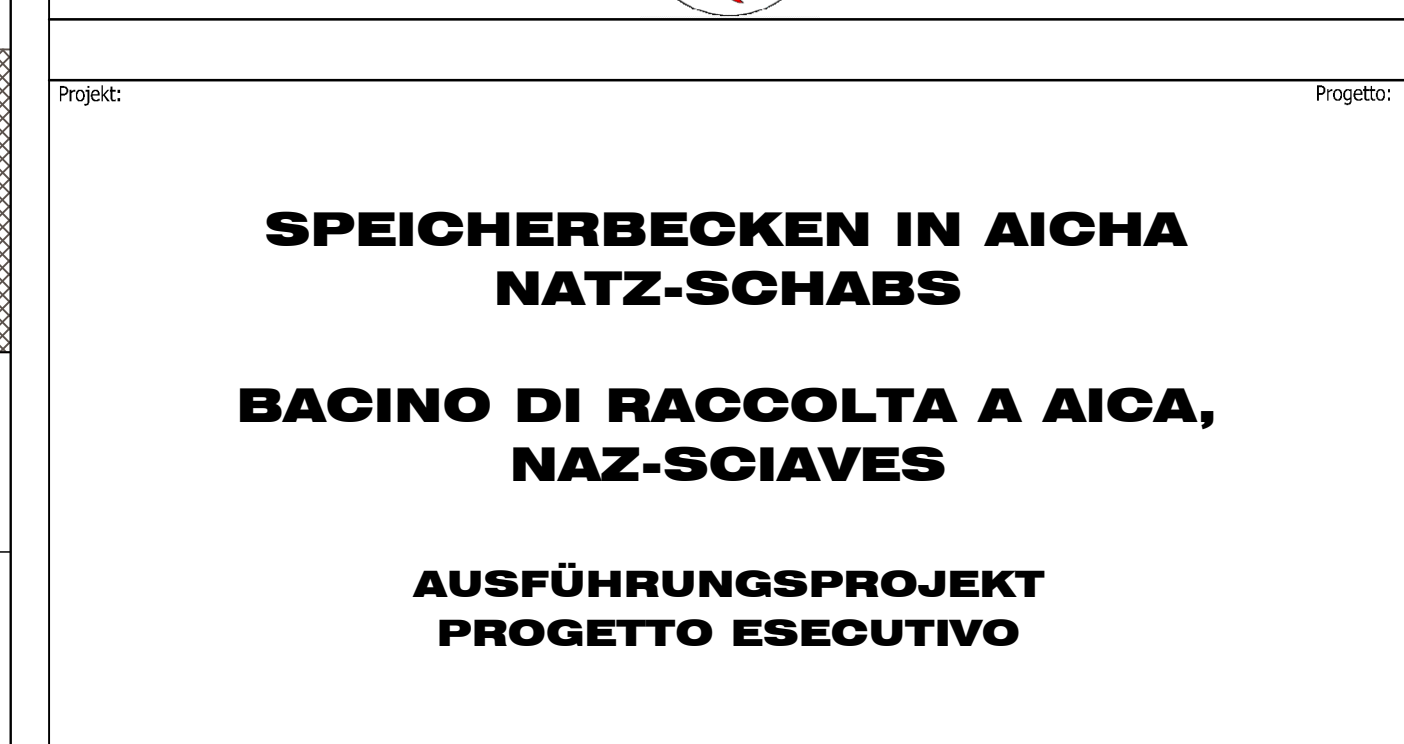
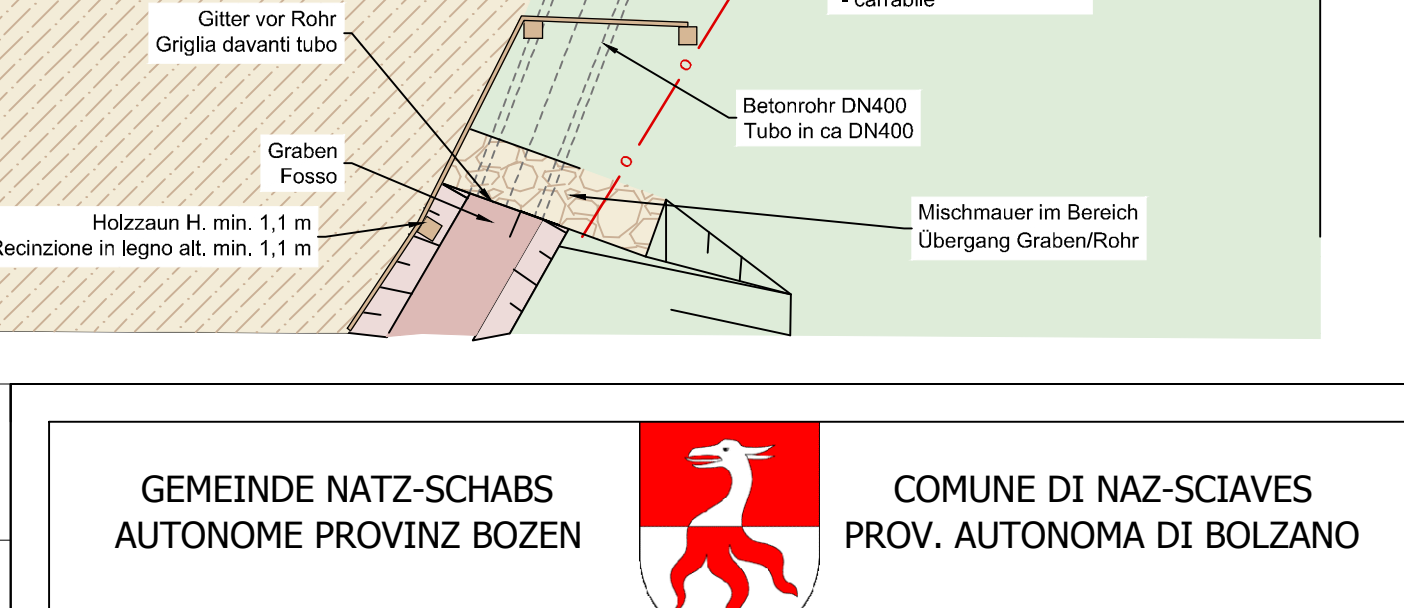
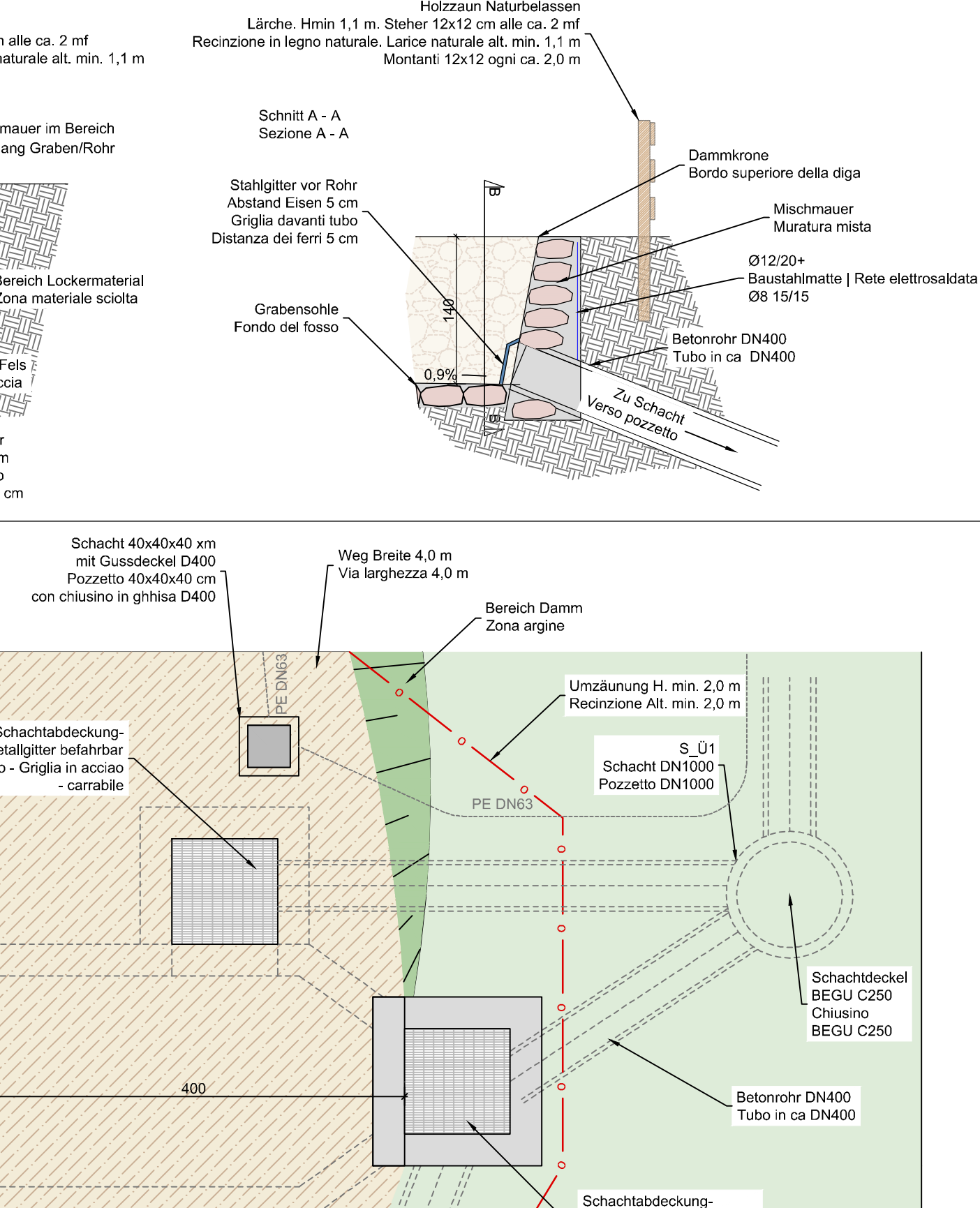

Überlaufbauwerk - Bewehrung 1:50  
Opera di sfiatore - armatura 1:50

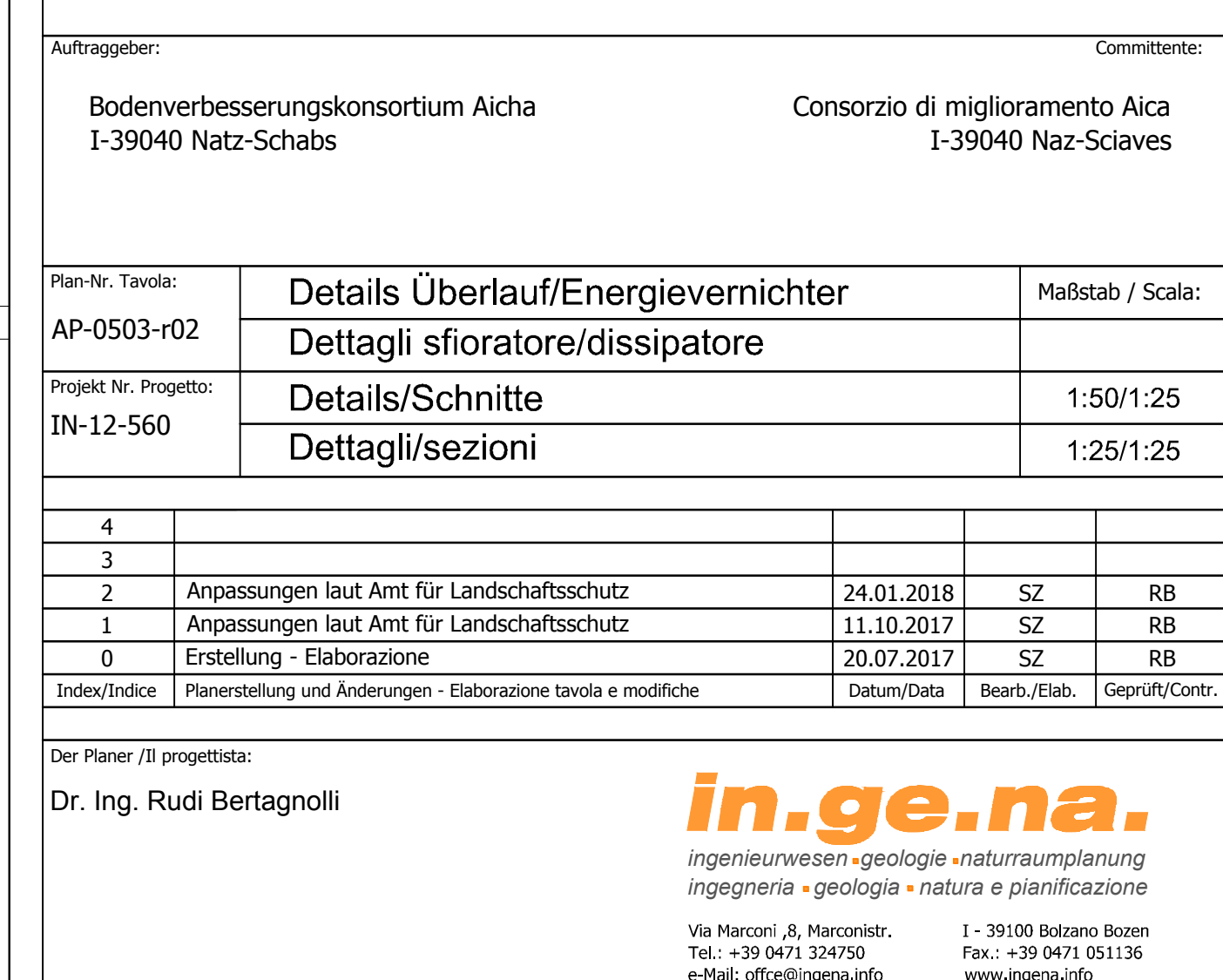
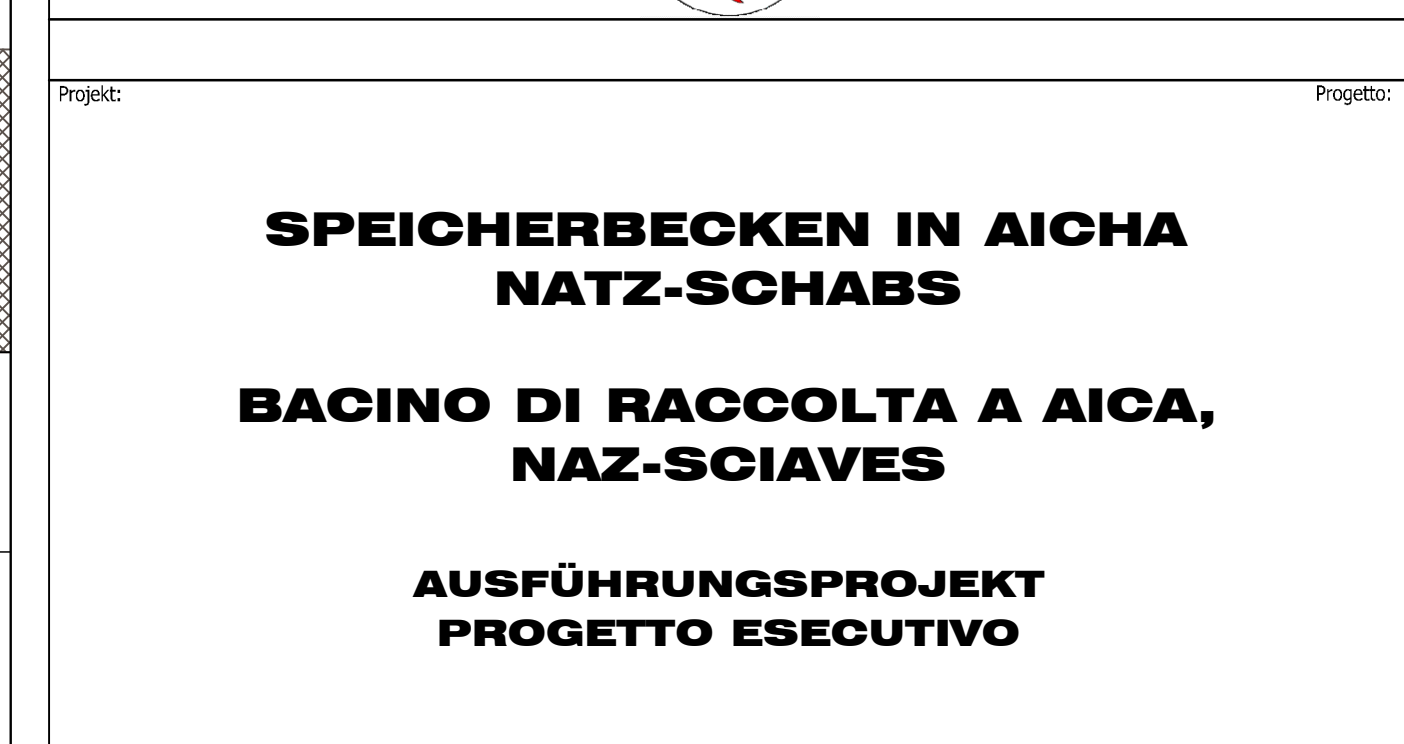
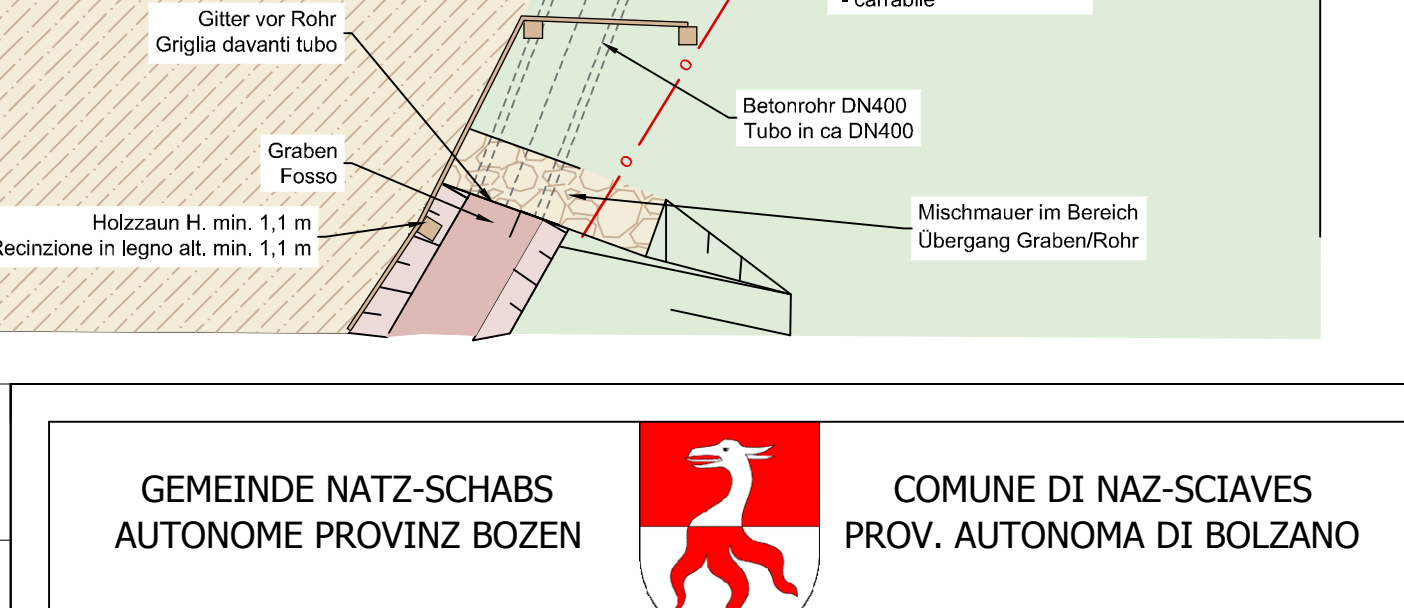
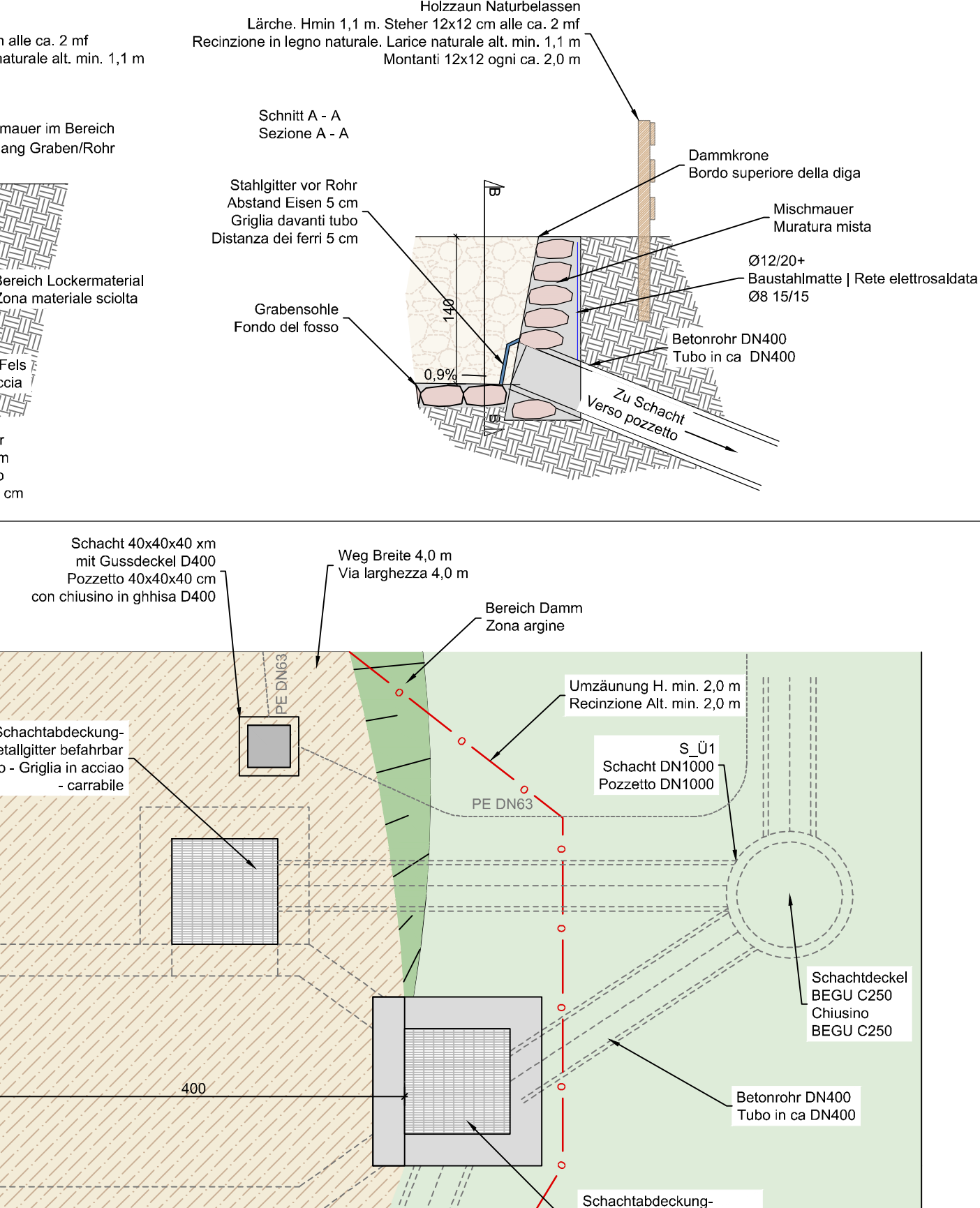

Überlaufbauwerk - Bewehrung 1:50  
Opera di sfiatore - armatura 1:50

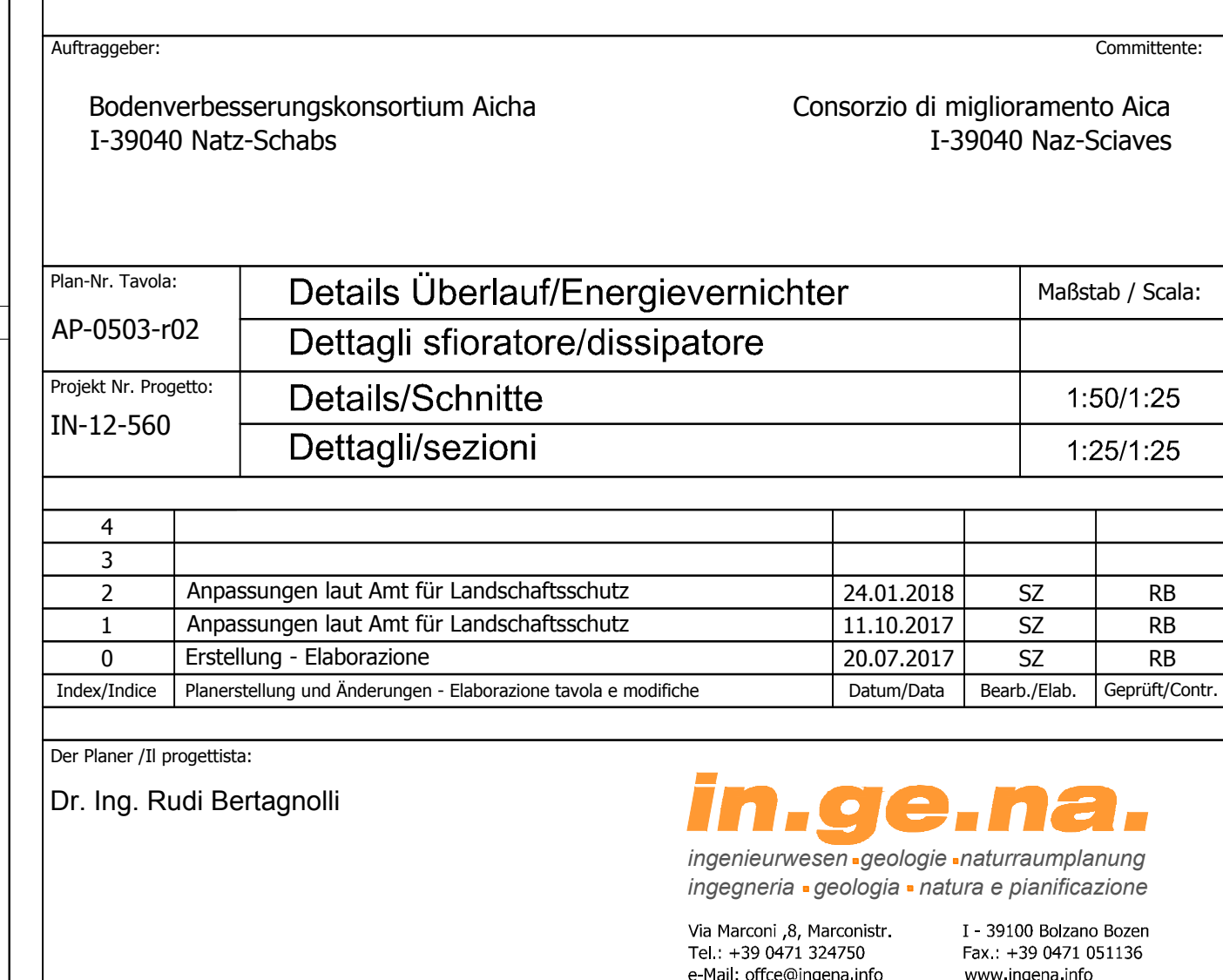
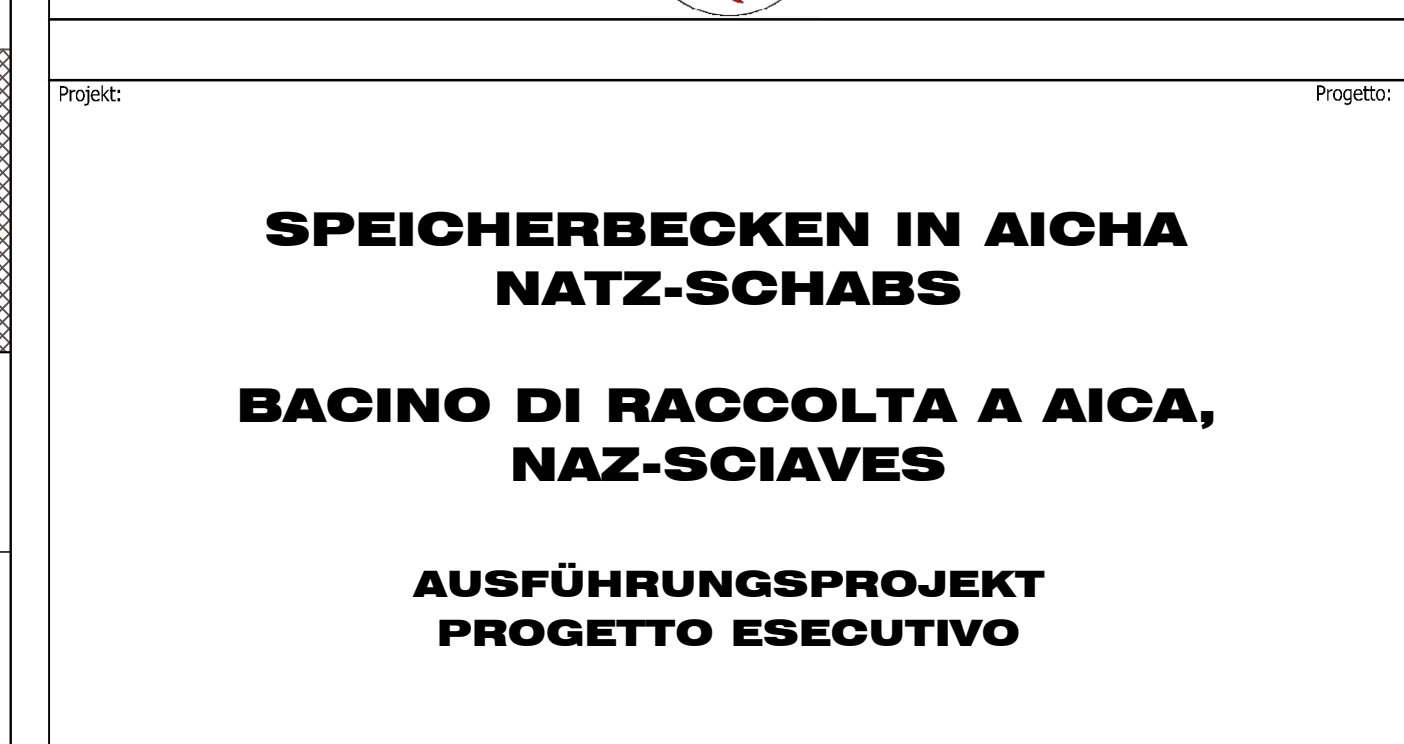
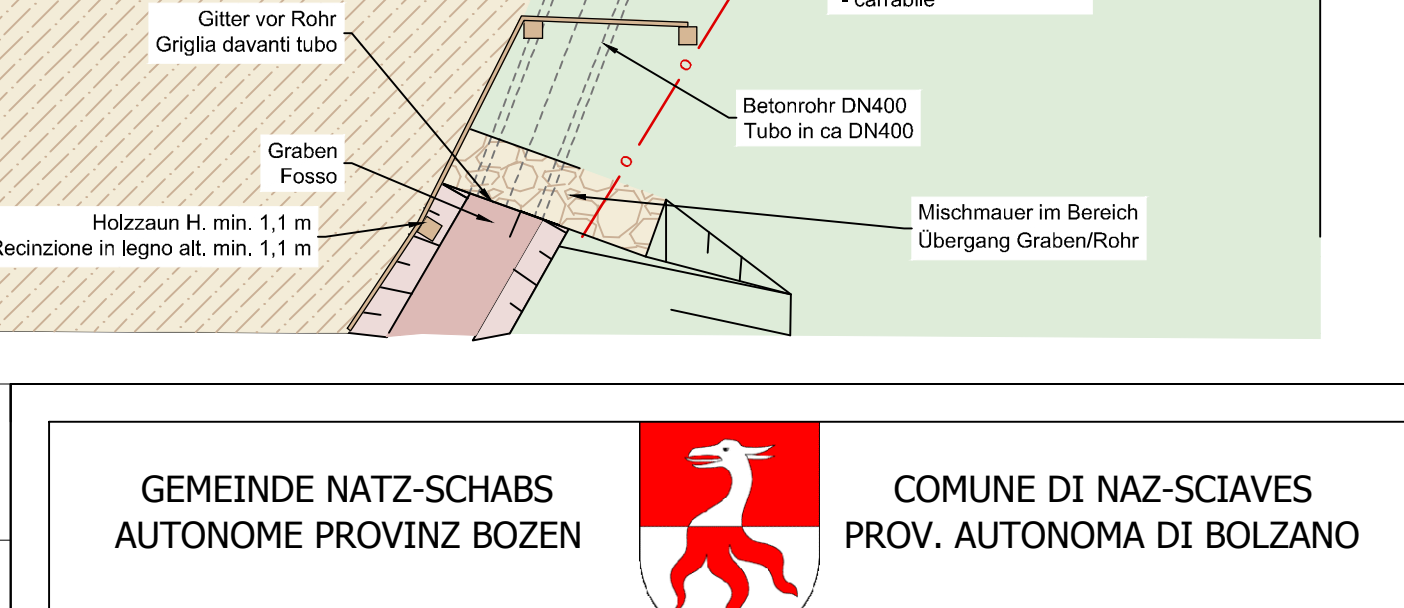
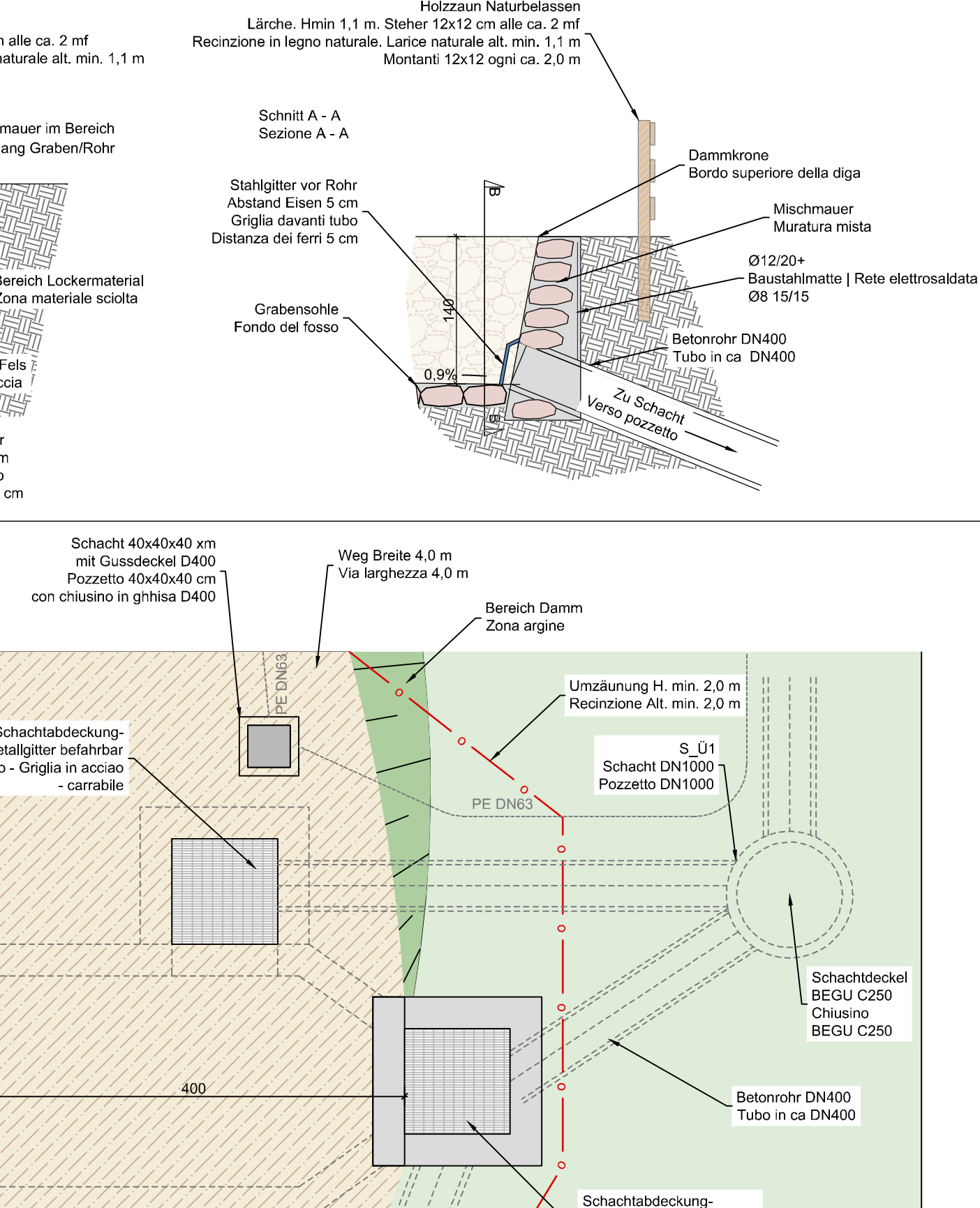

Überlaufbauwerk - Bewehrung 1:50  
Opera di sfiatore - armatura 1:50

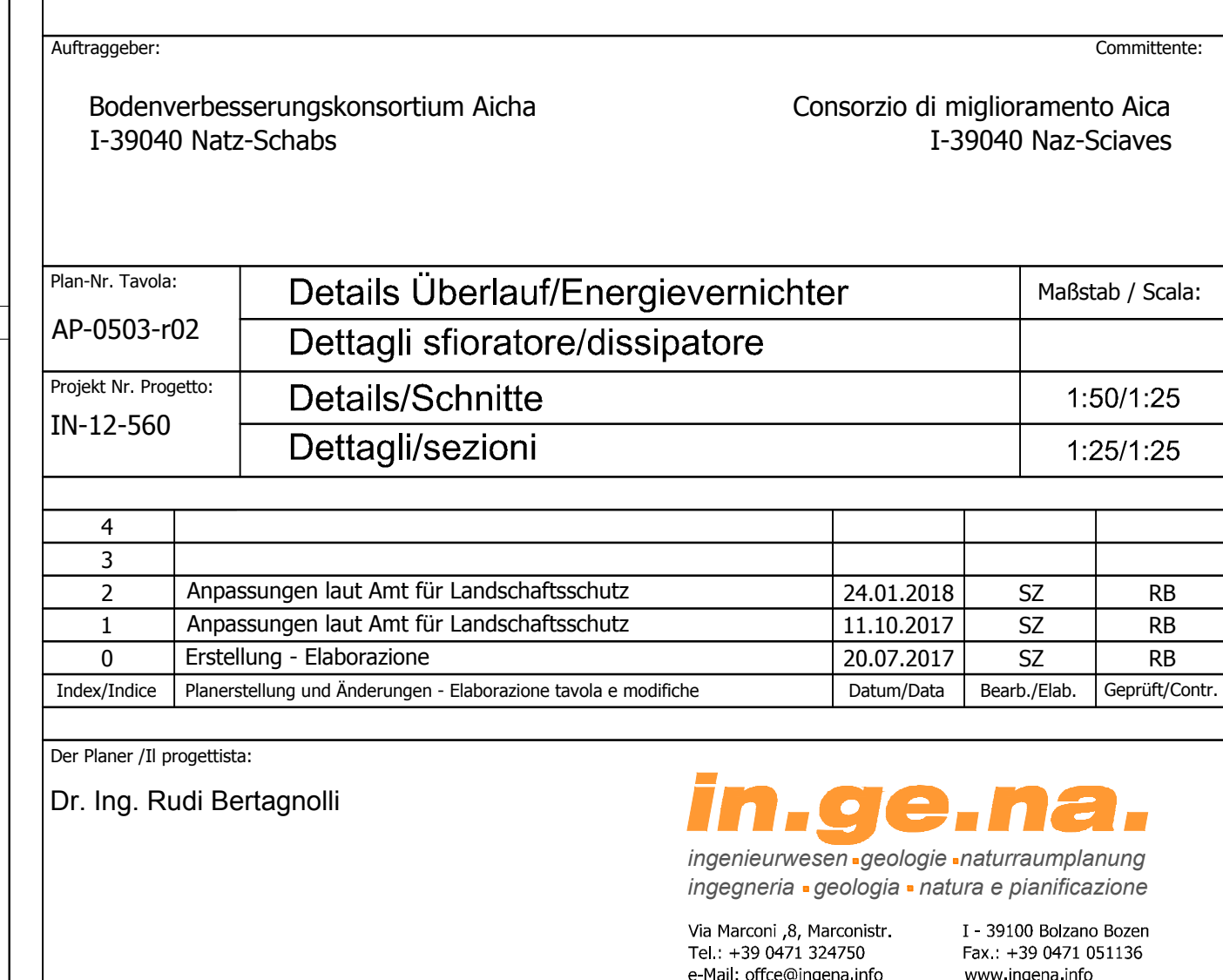
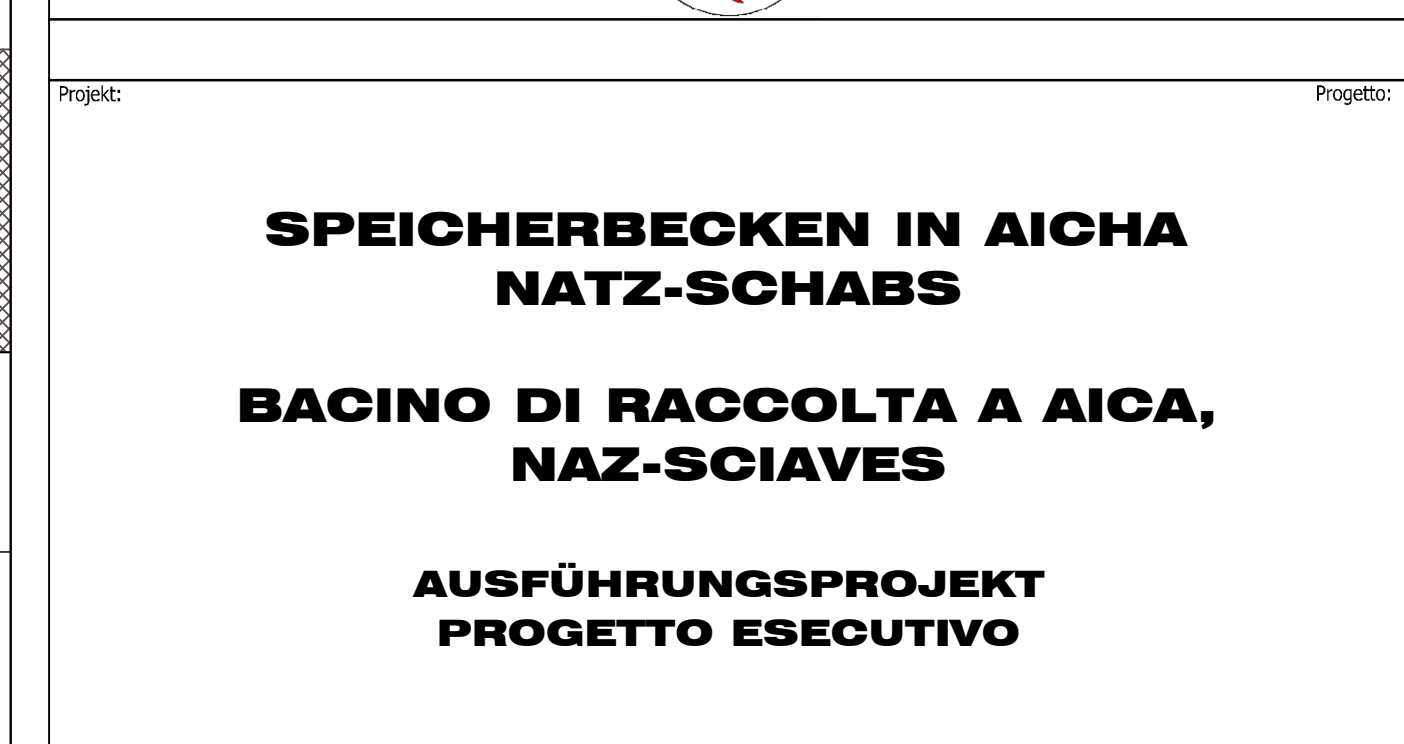
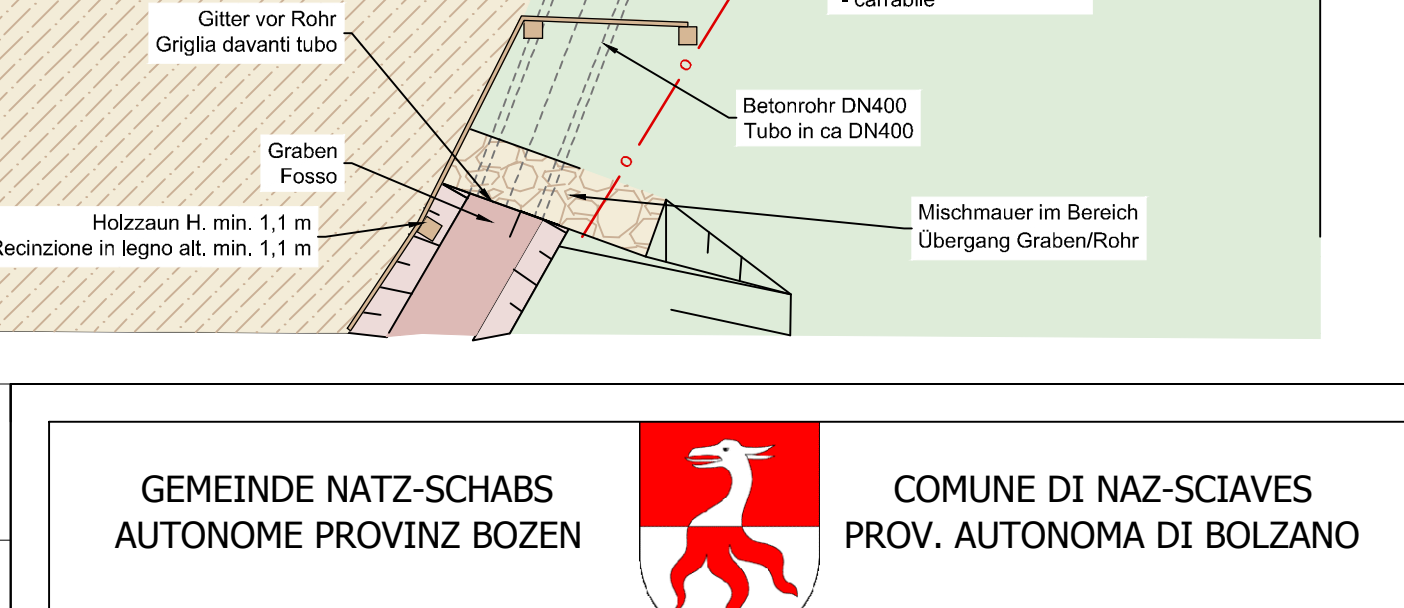
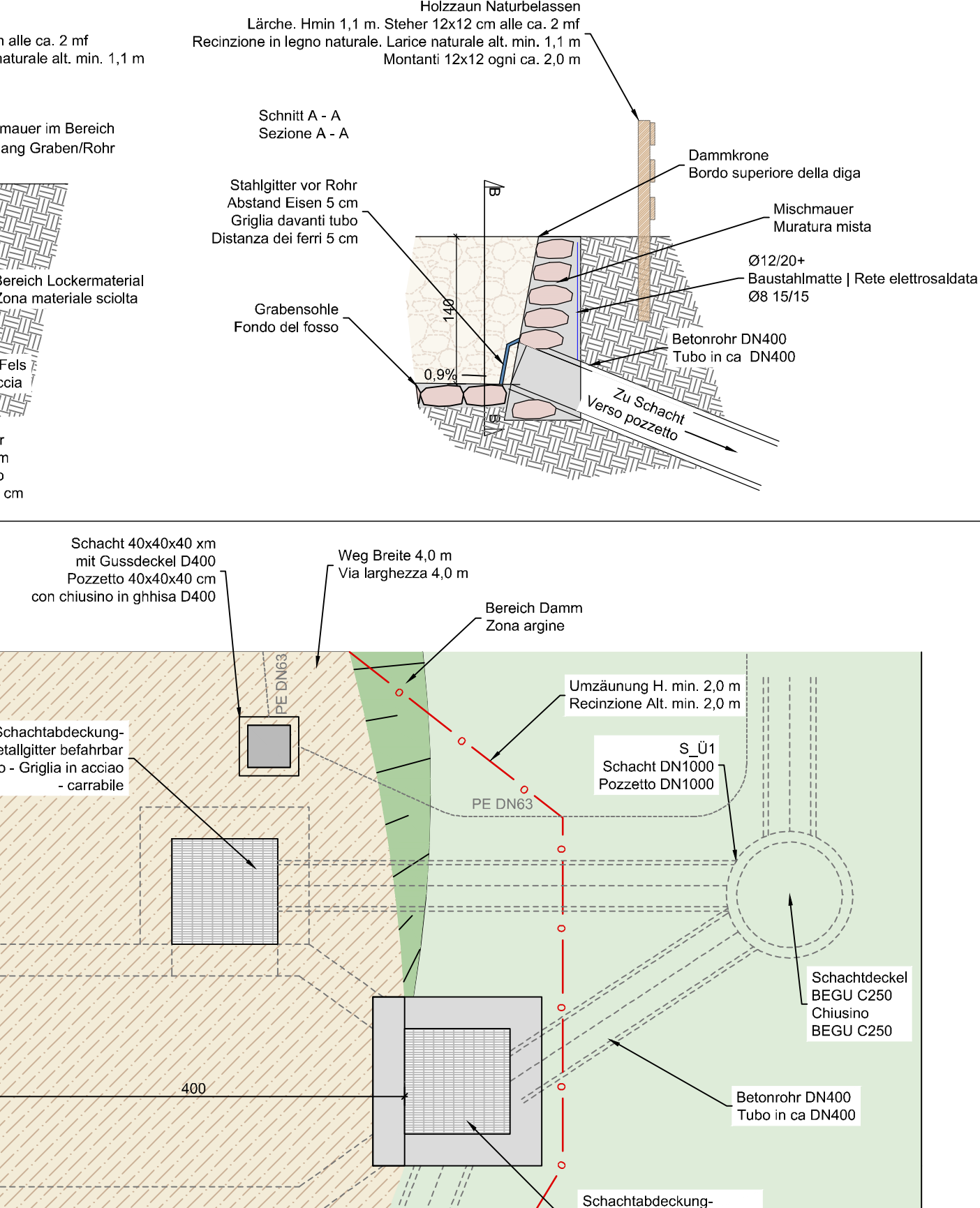

Überlaufbauwerk - Bewehrung 1:50  
Opera di sfiatore - armatura 1:50

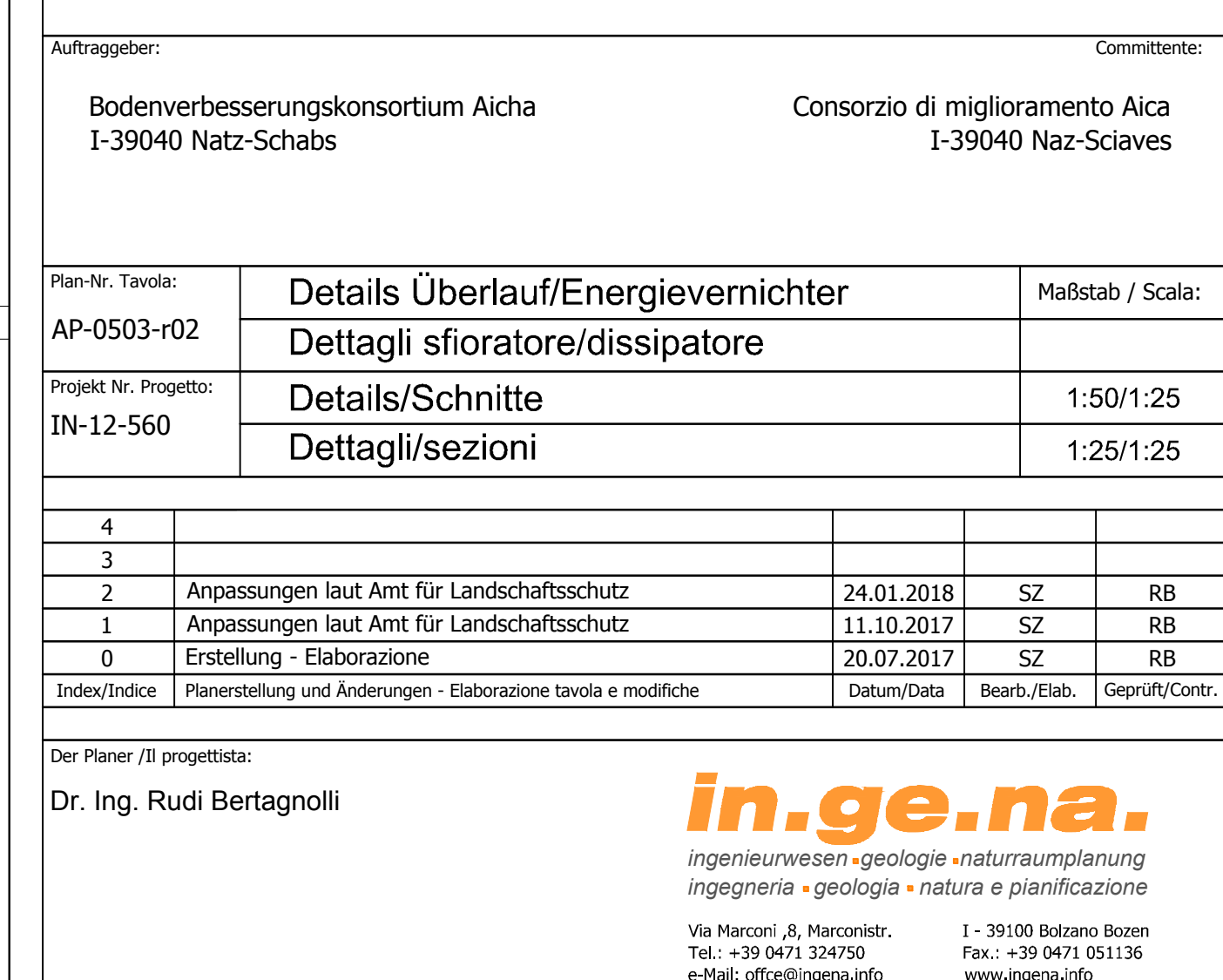
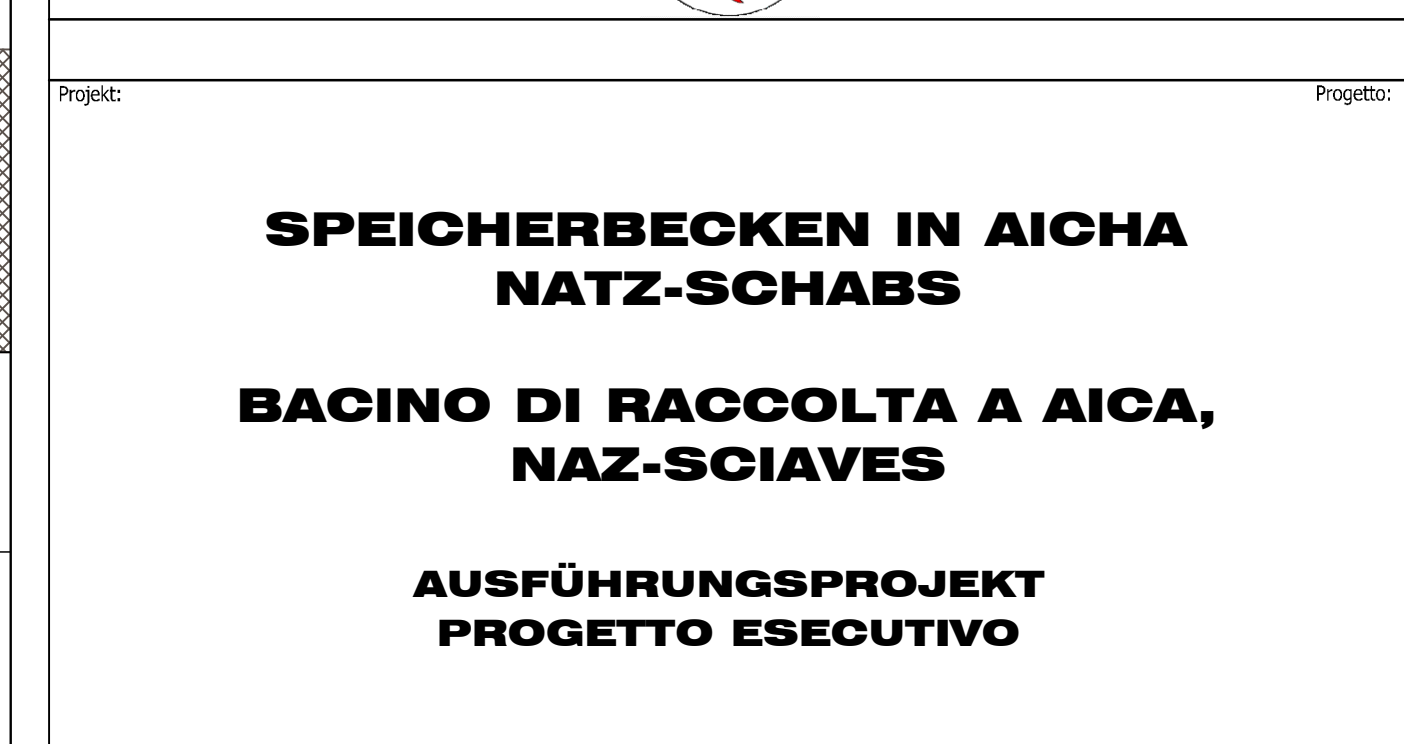
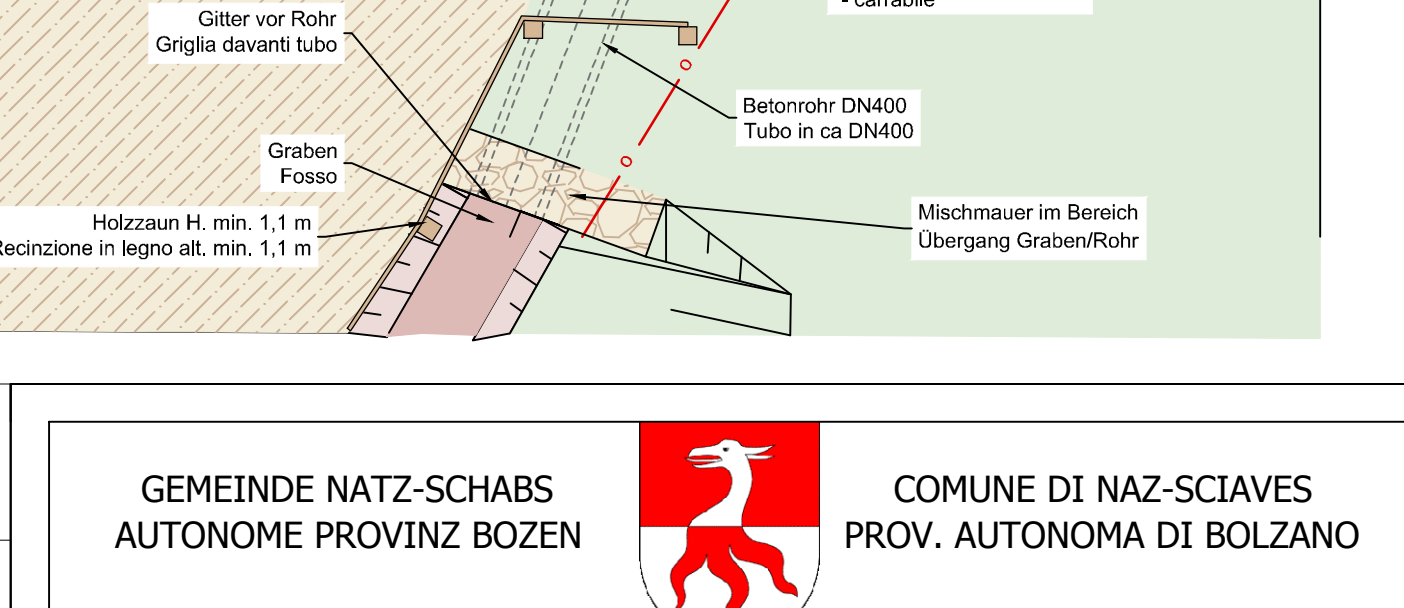
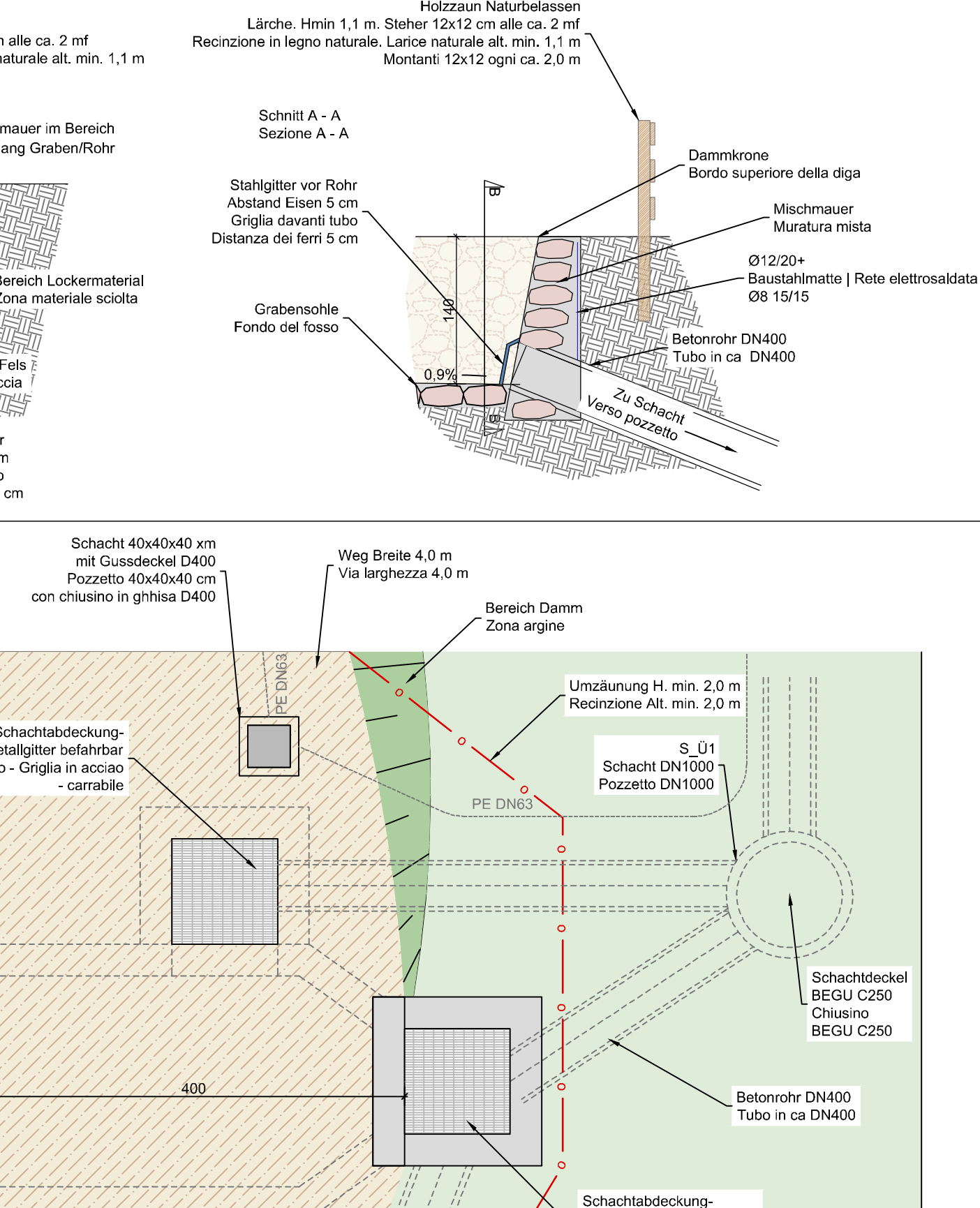

Überlaufbauwerk - Bewehrung 1:50  
Opera di sfiatore - armatura 1:50

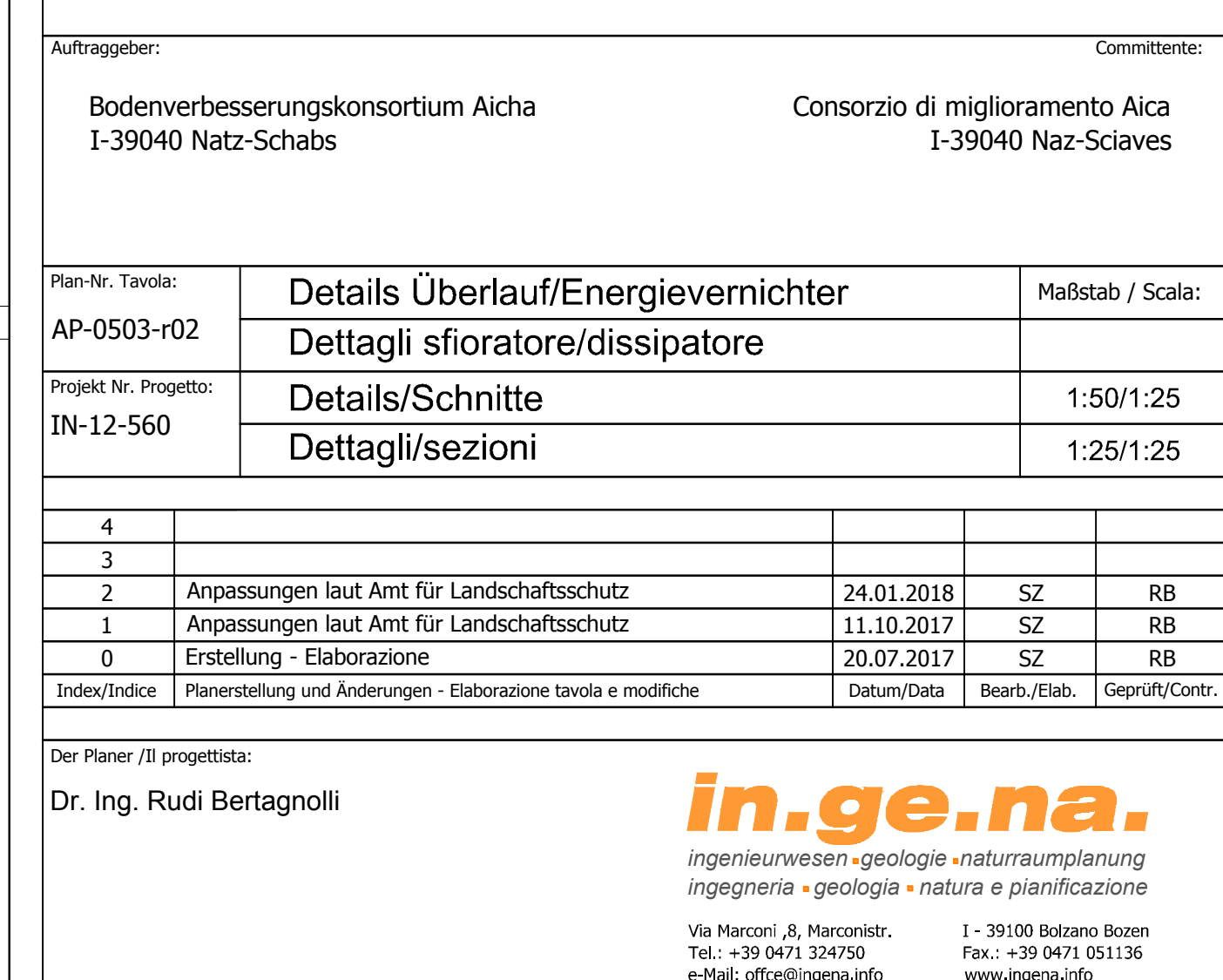
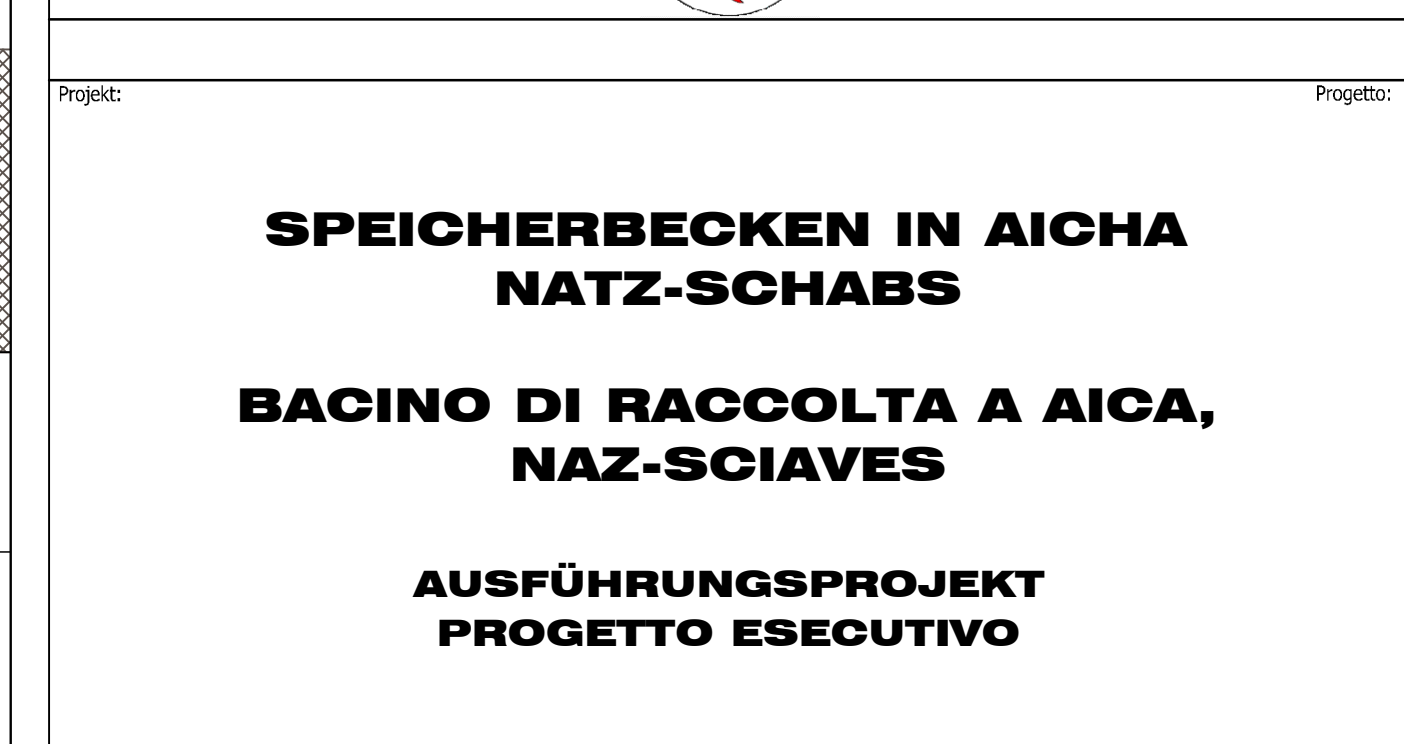
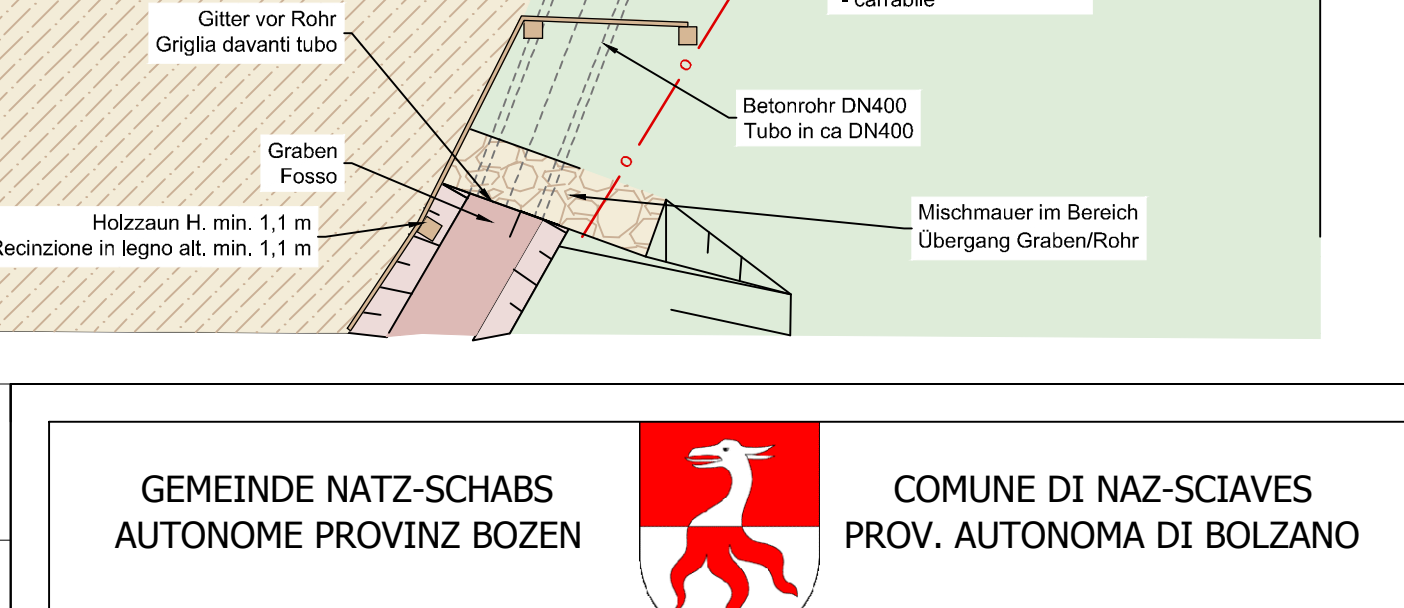
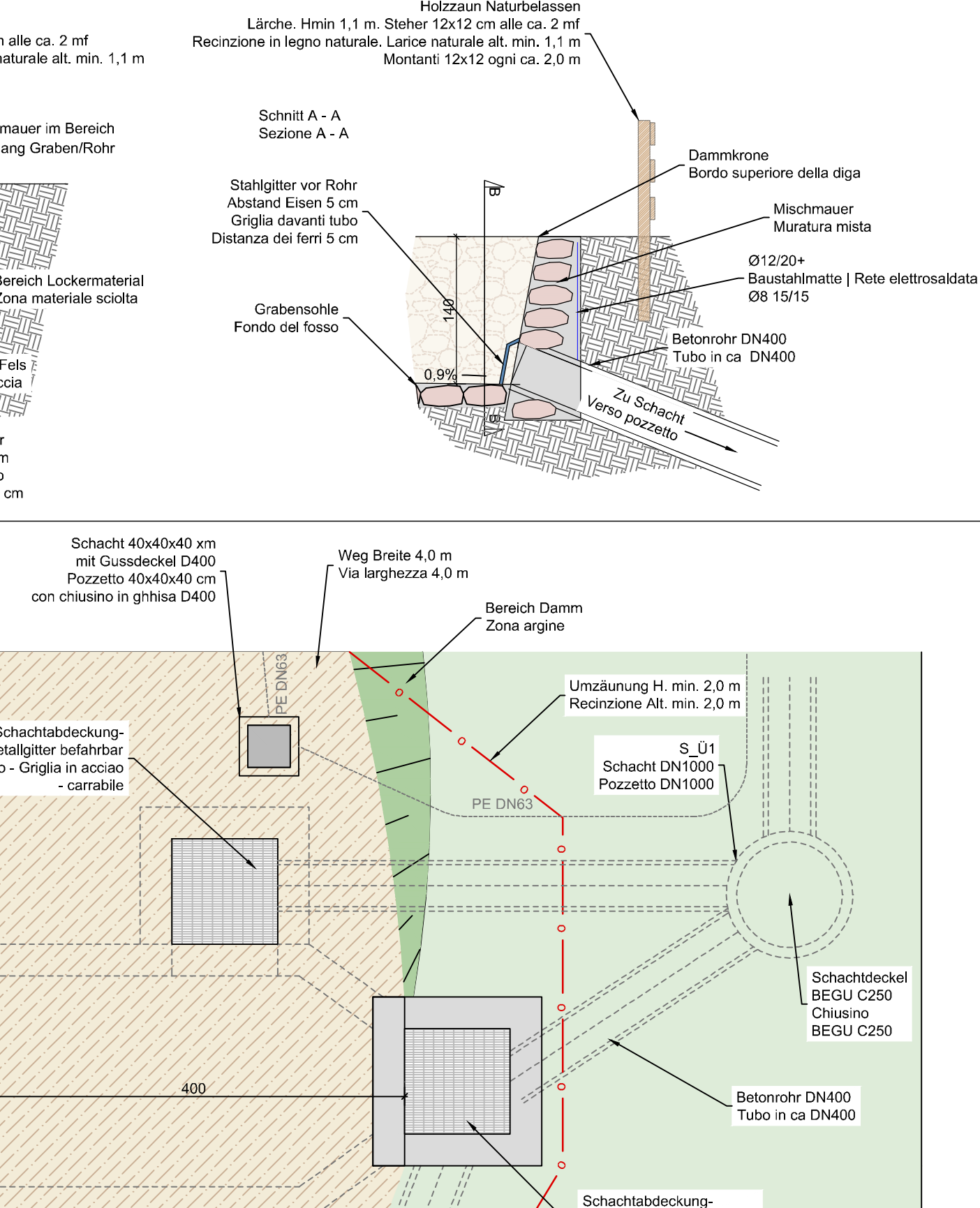

Überlaufbauwerk - Bewehrung 1:50  
Opera di sfiatore - armatura 1:50

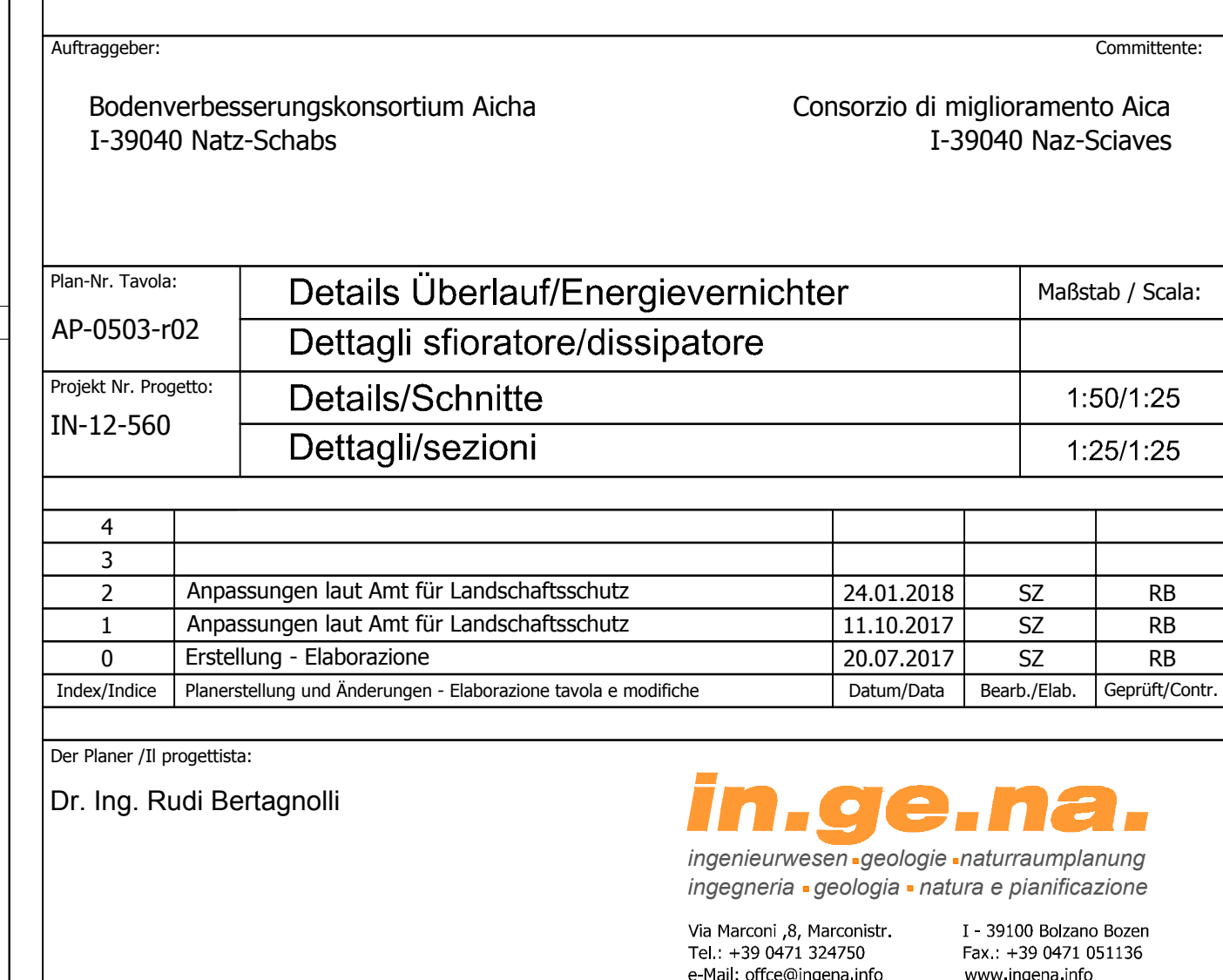
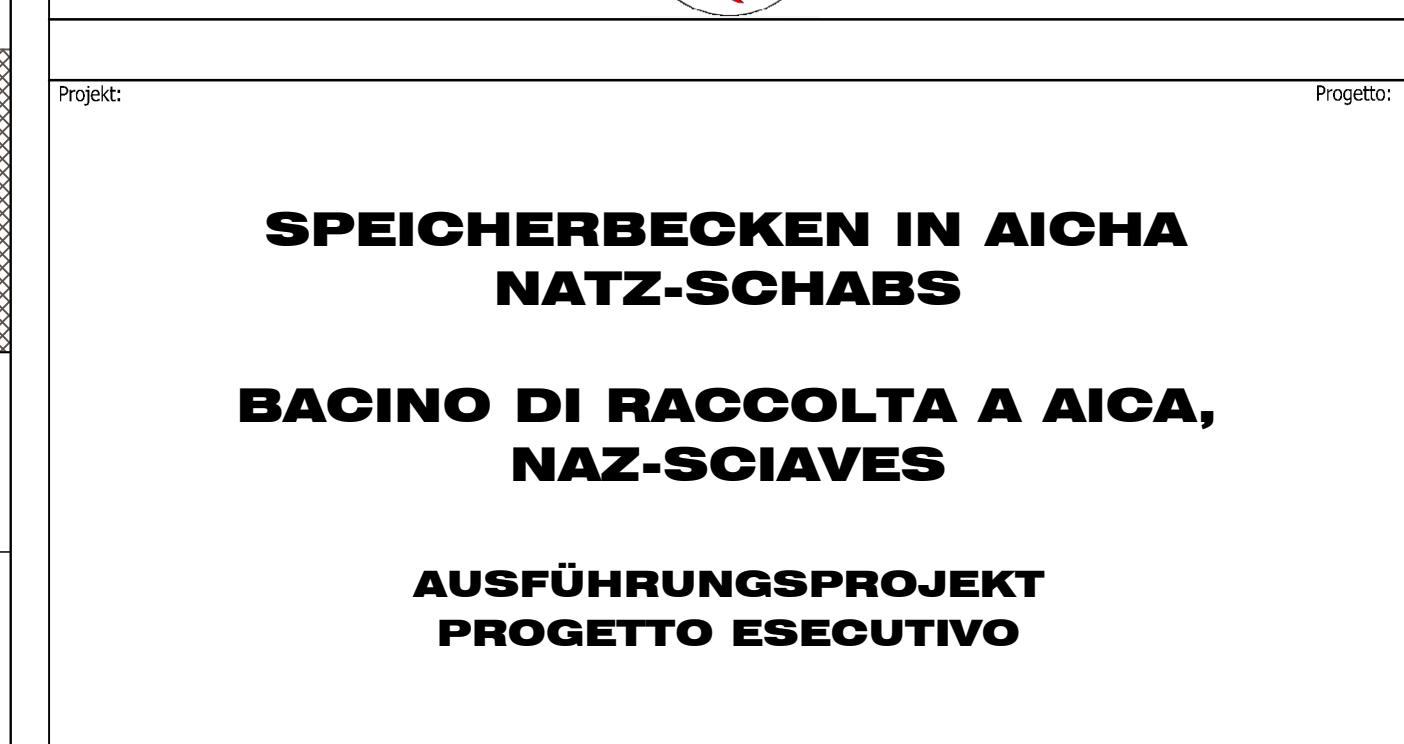
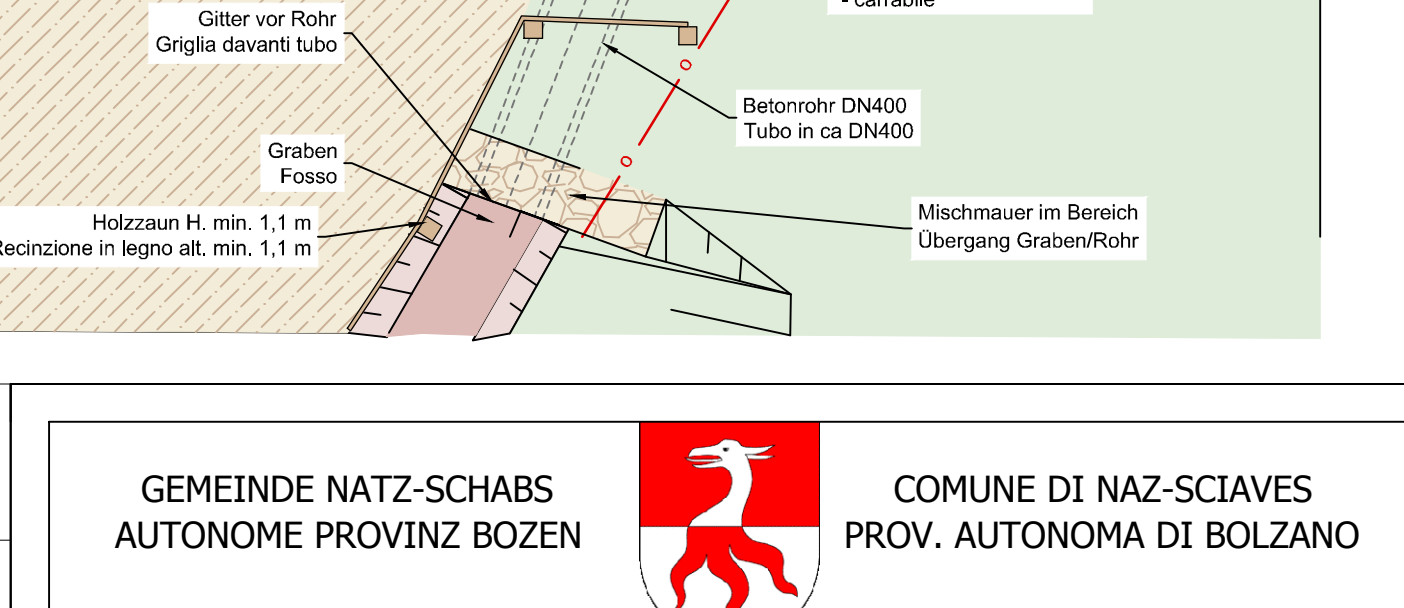
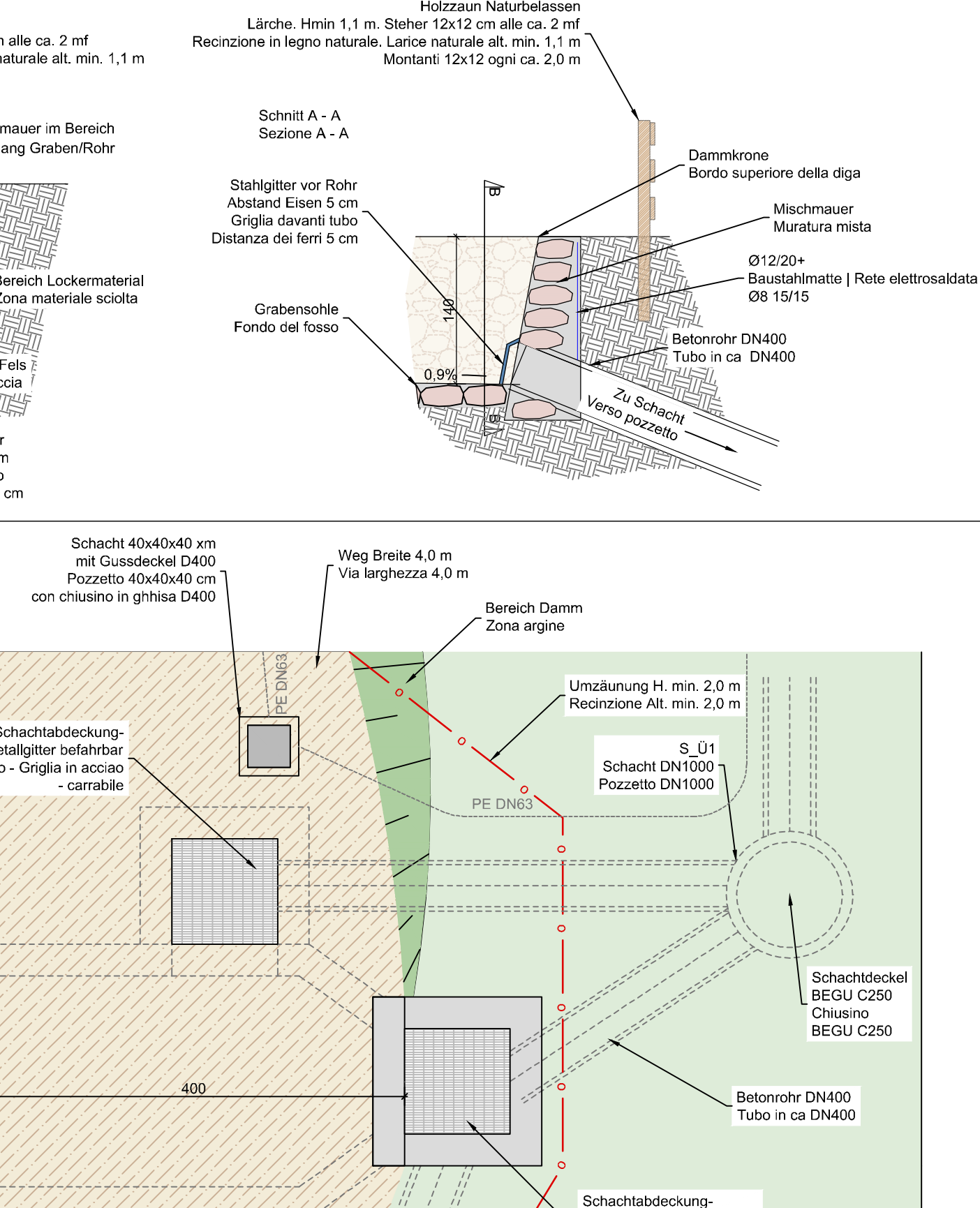

Überlaufbauwerk - Bewehrung 1:50  
Opera di sfiatore - armatura 1:50

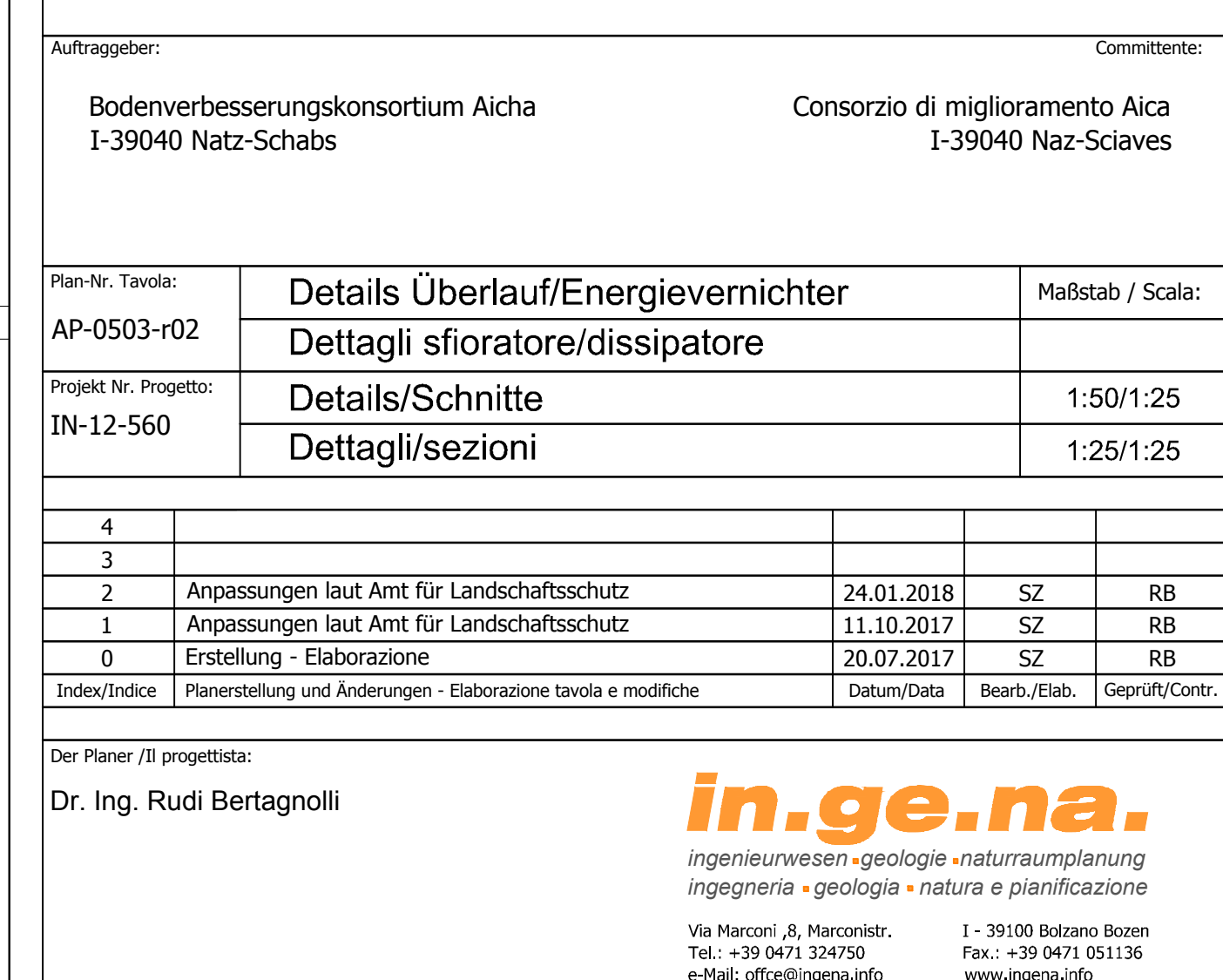
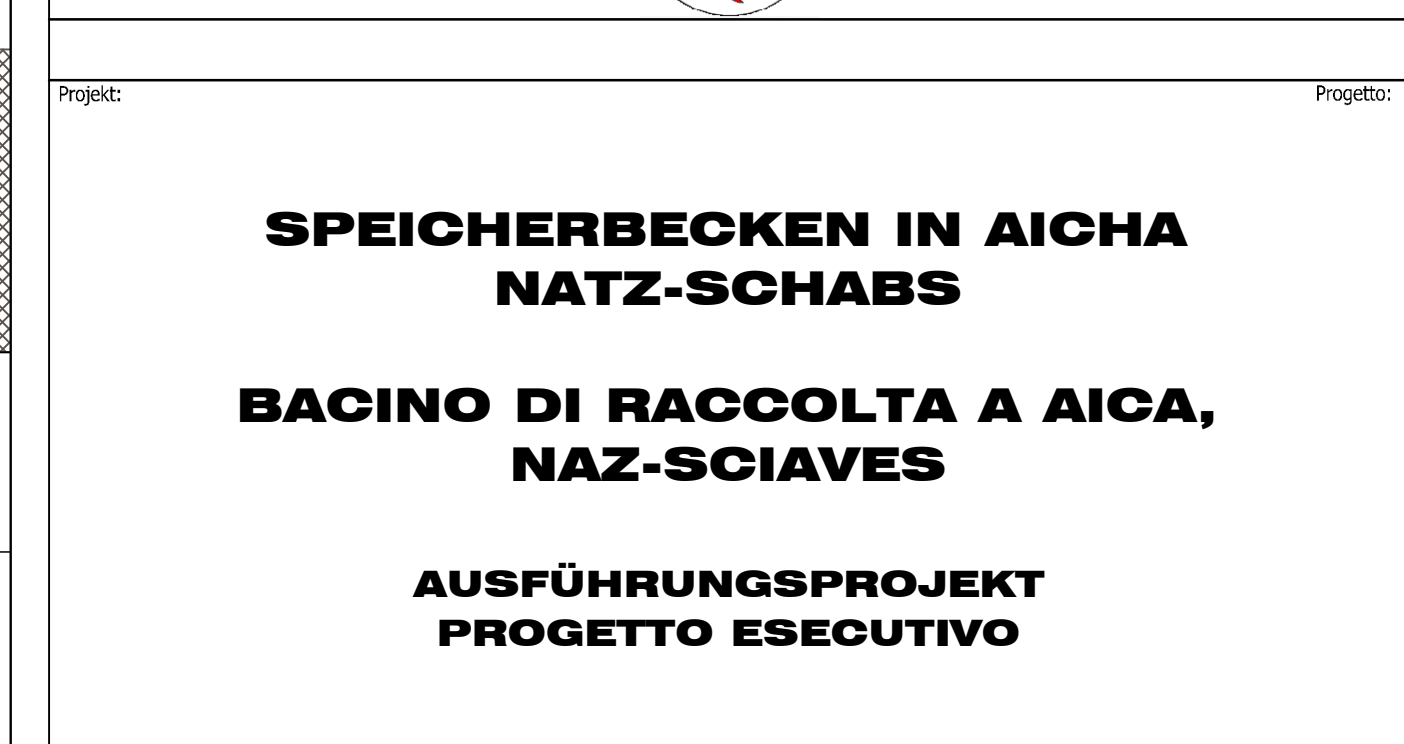
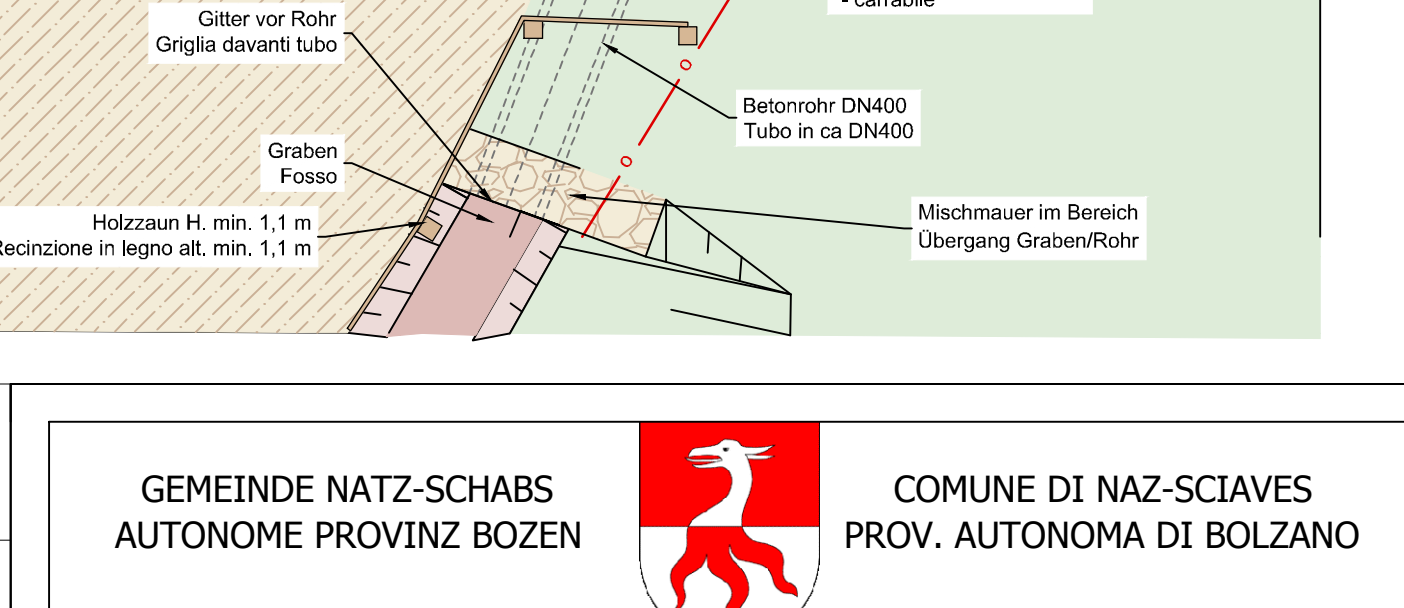
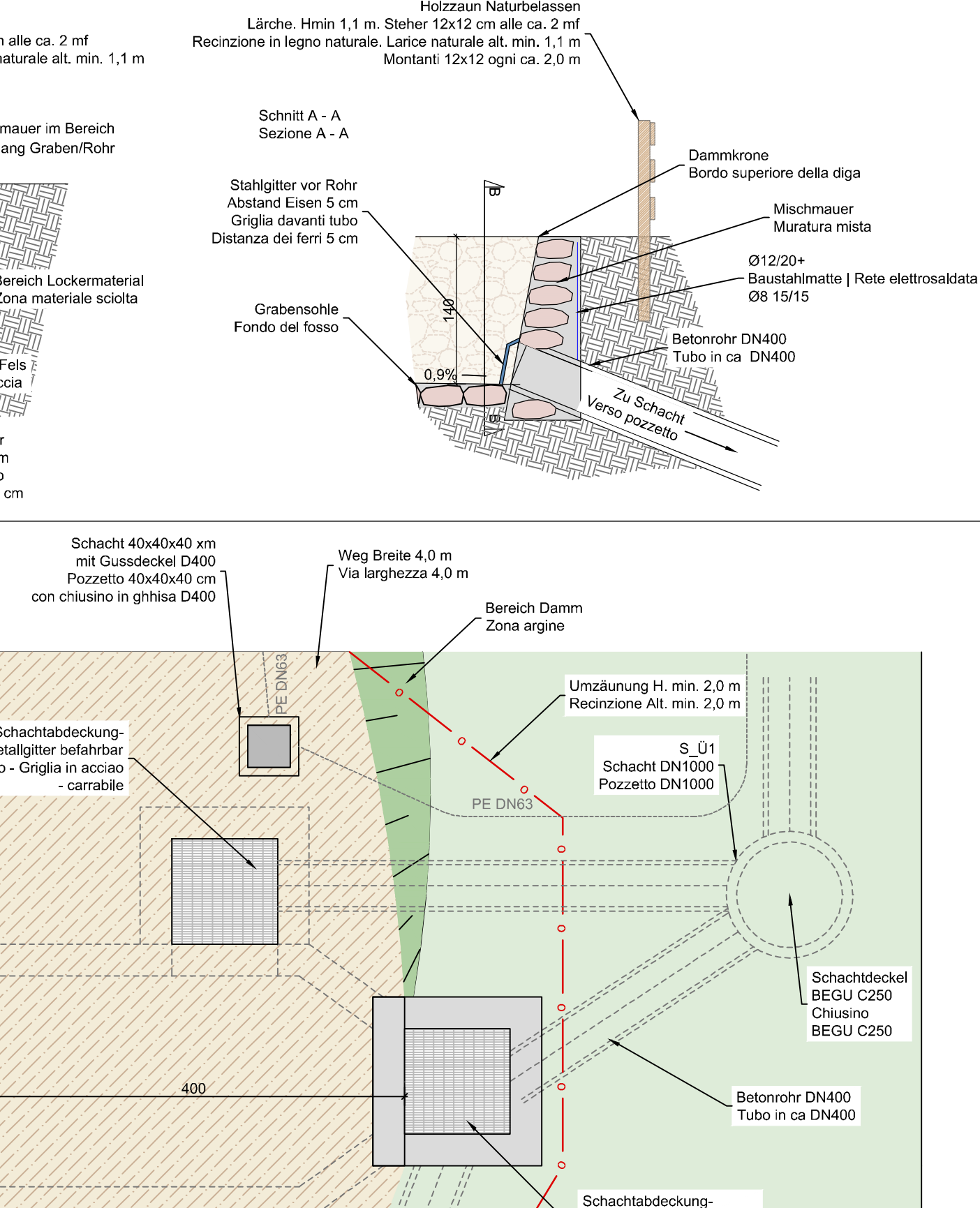

Überlaufbauwerk - Bewehrung 1:50  
Opera di sfiatore - armatura 1:50

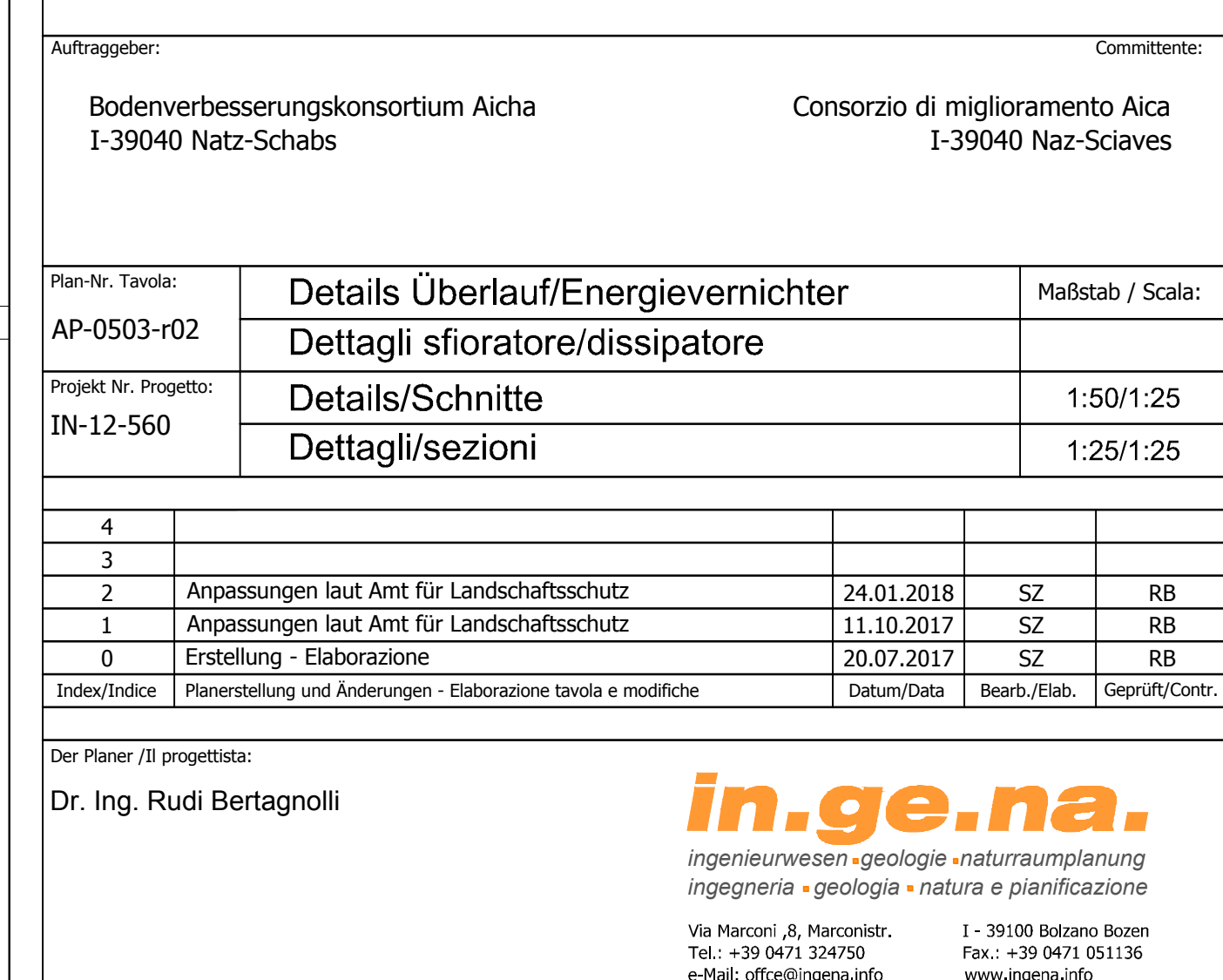
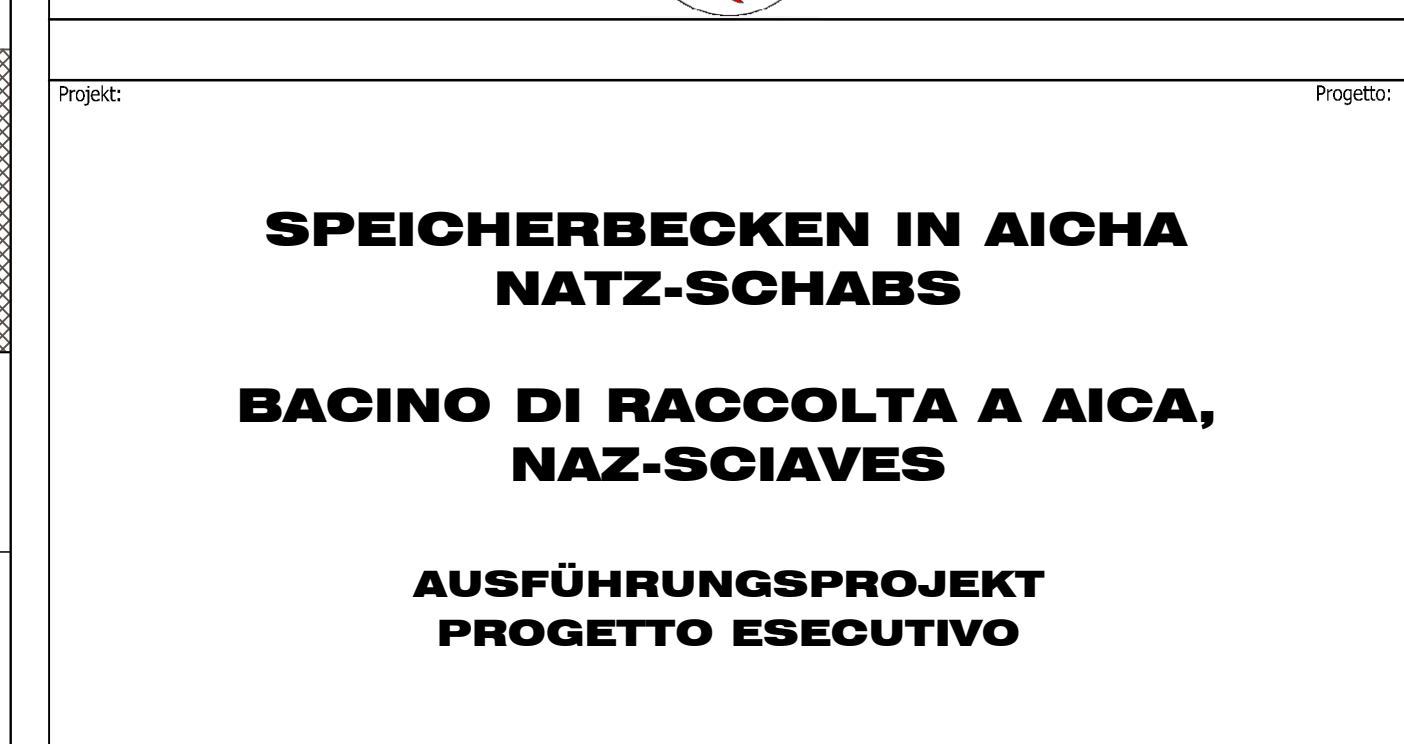
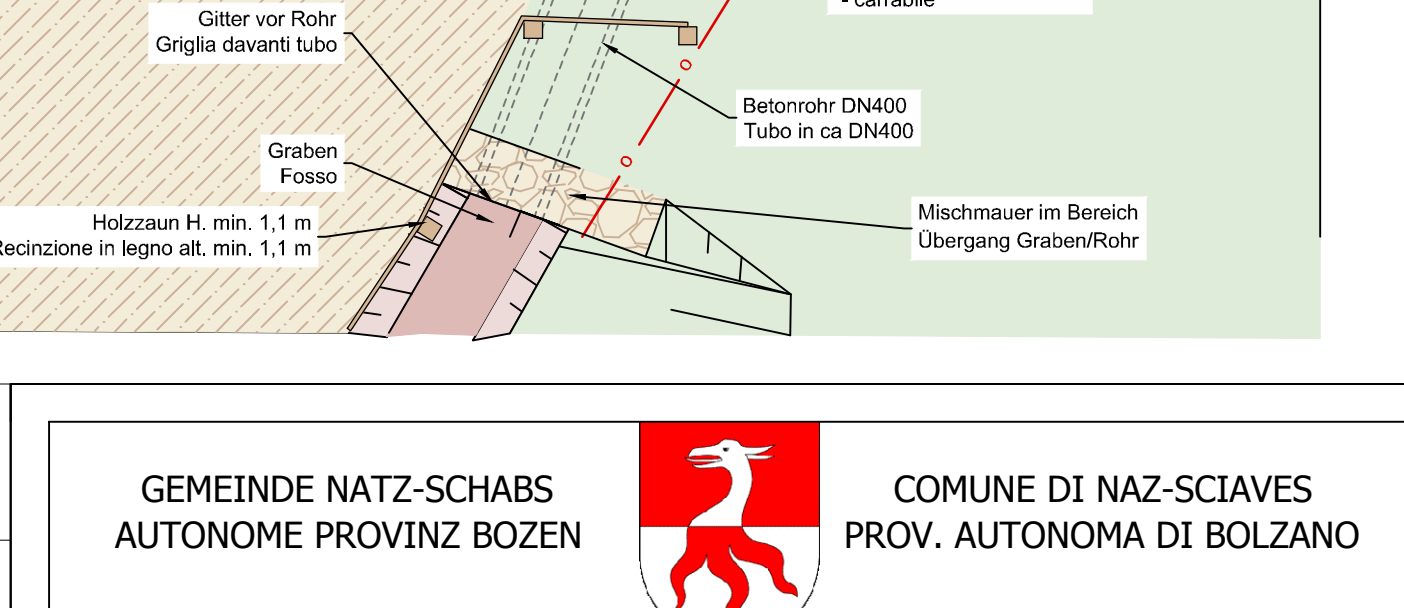
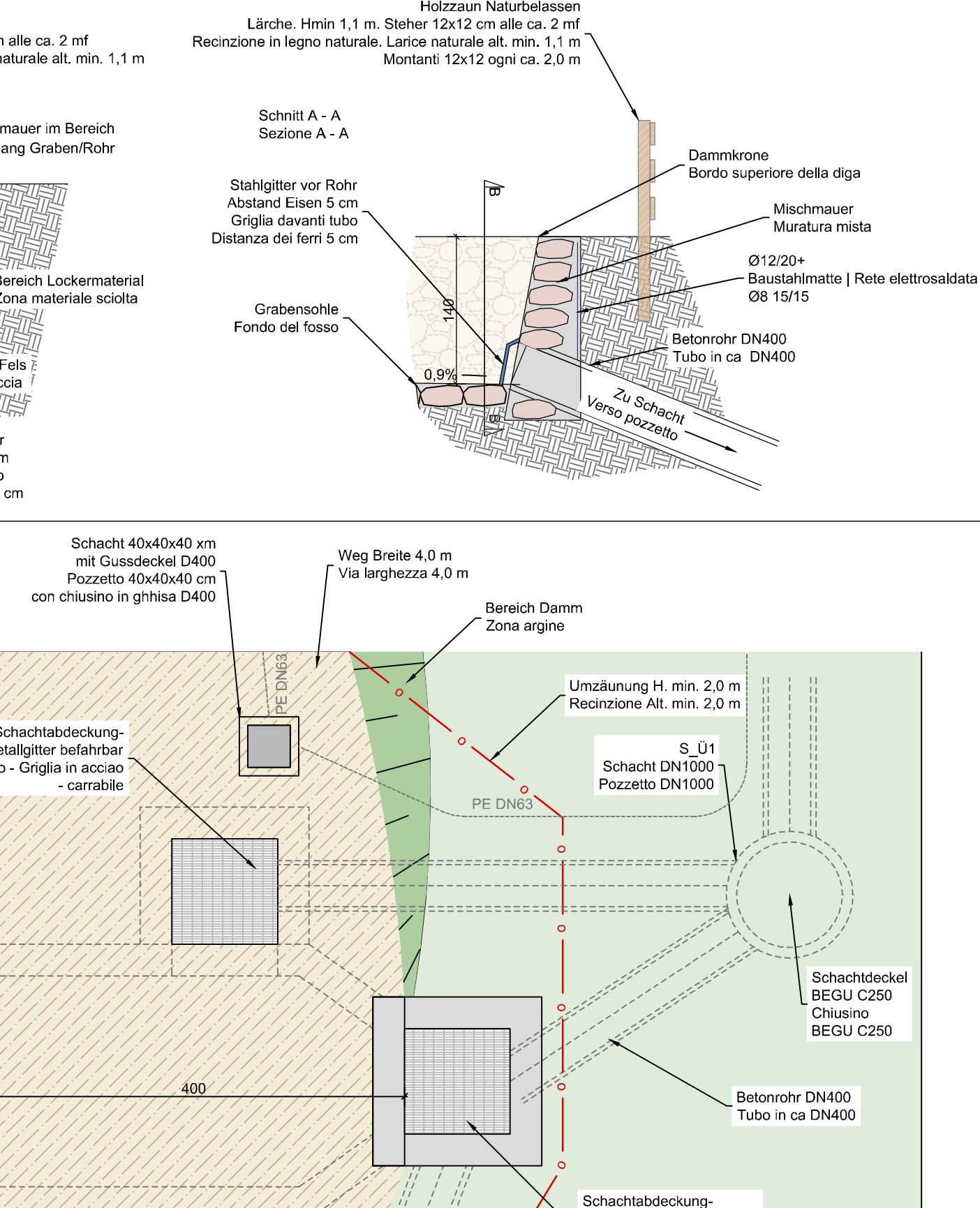

Überlaufbauwerk - Bewehrung 1:50  
Opera di sfiatore - armatura 1:50

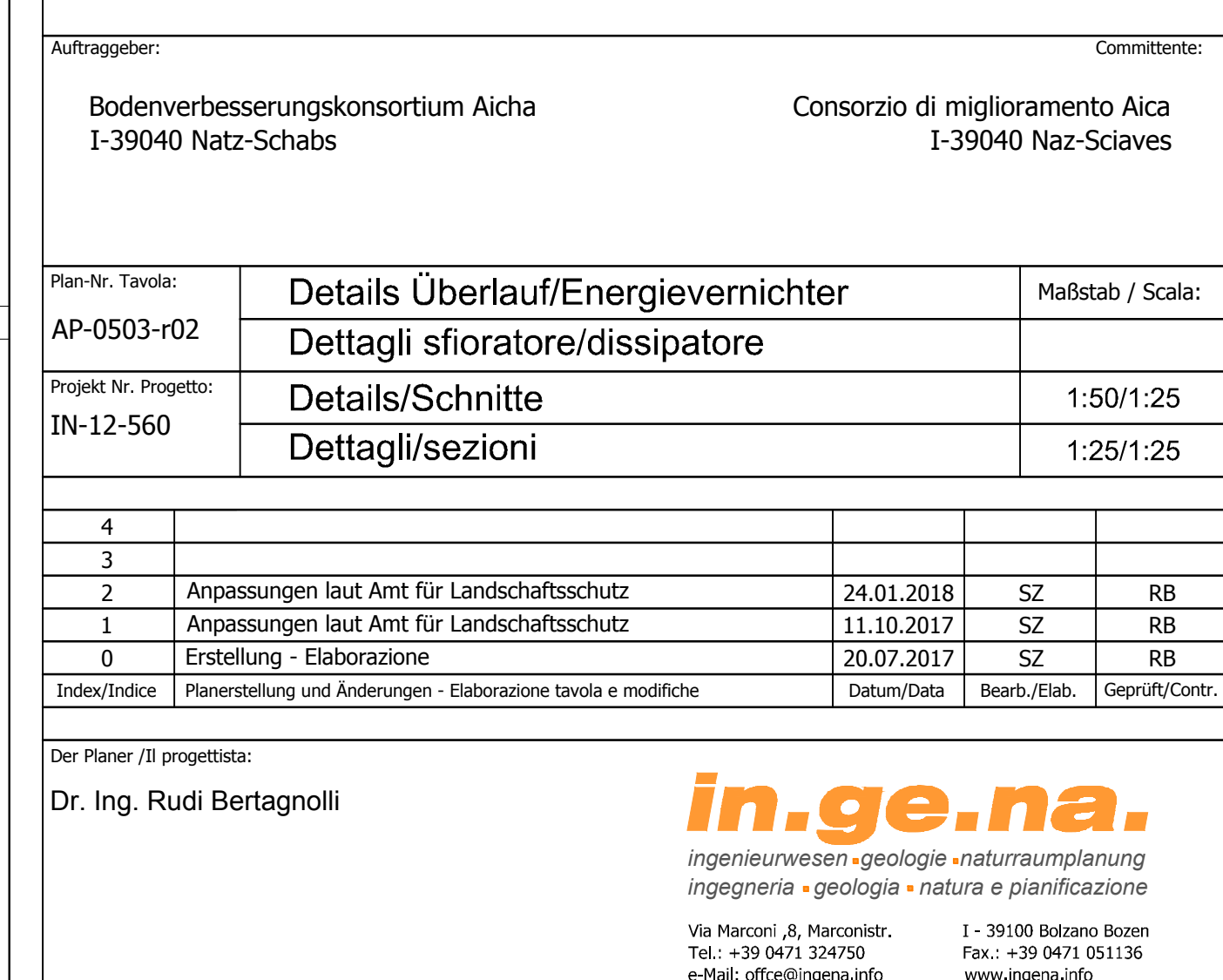
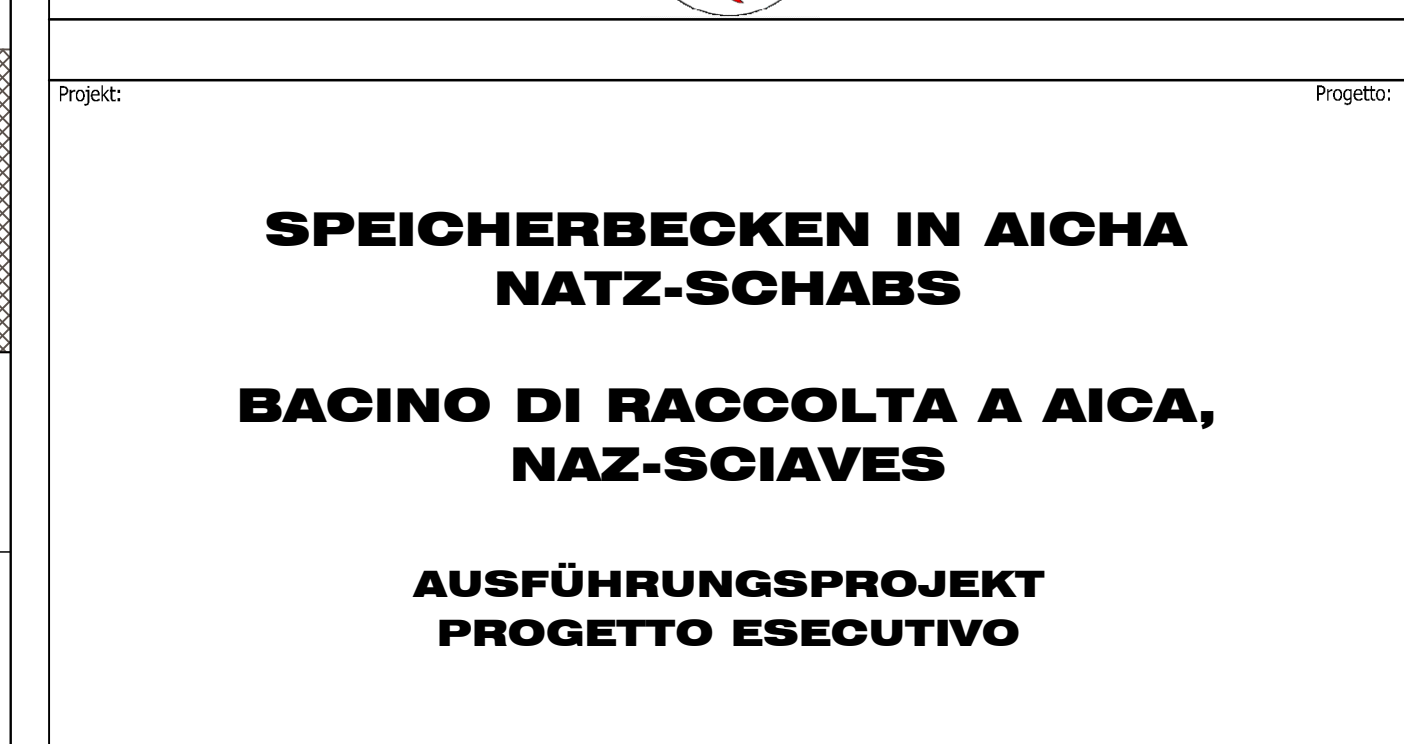
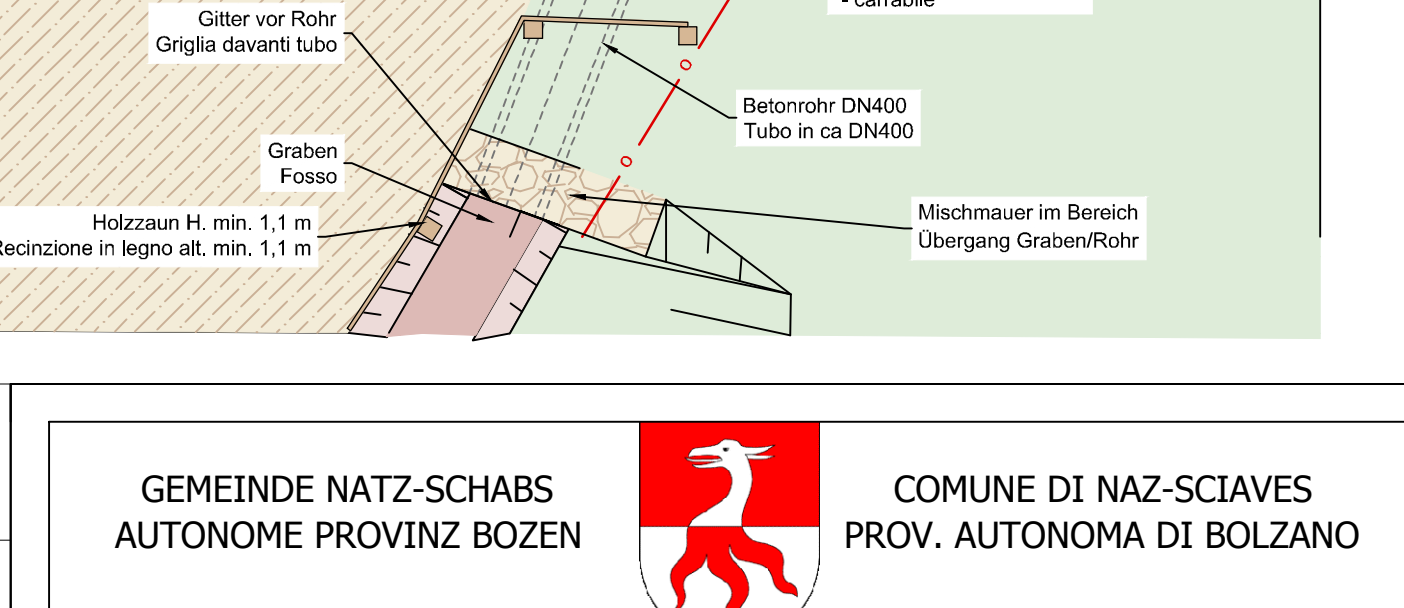
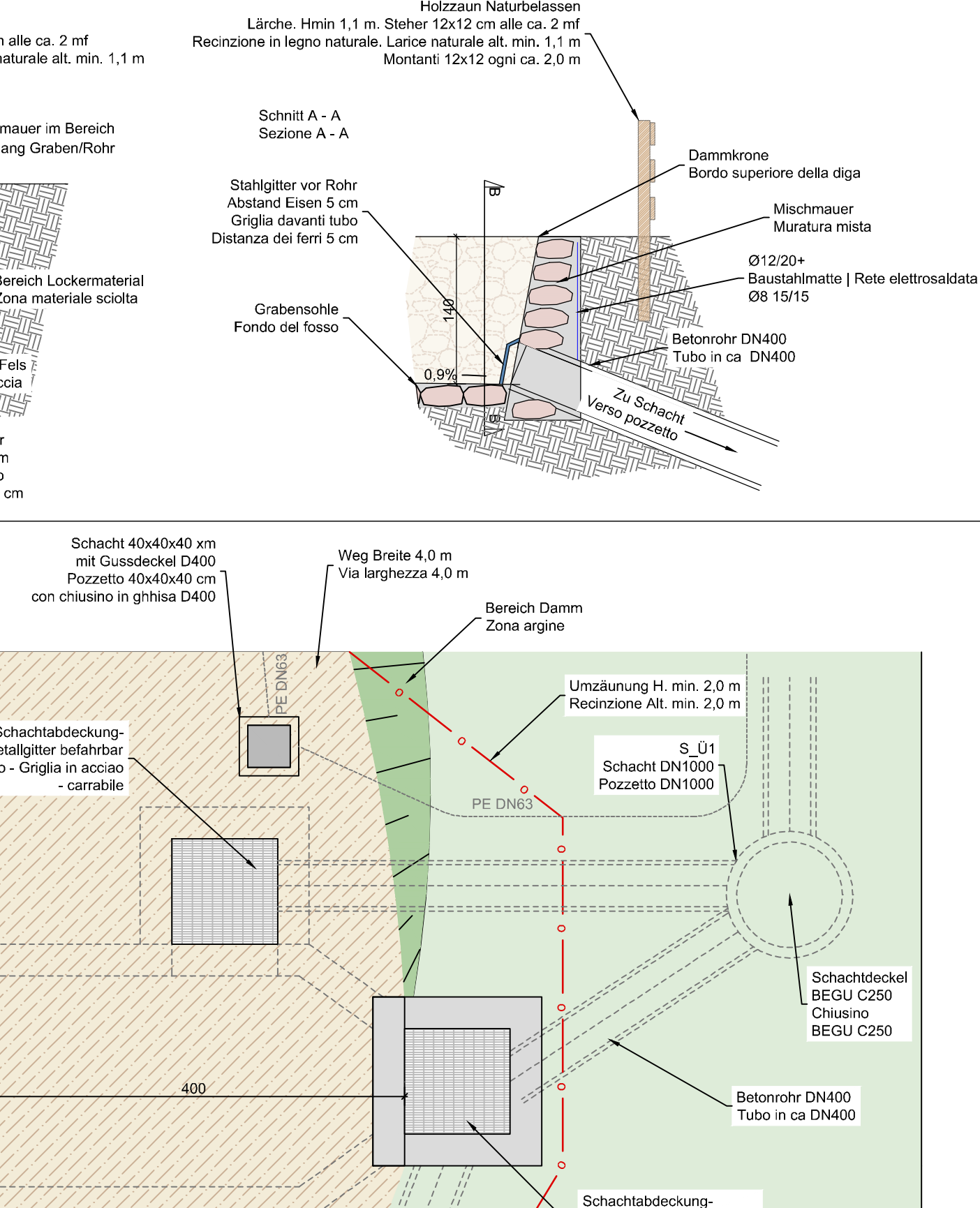

Überlaufbauwerk - Bewehrung 1:50  
Opera di sfiatore - armatura 1:50

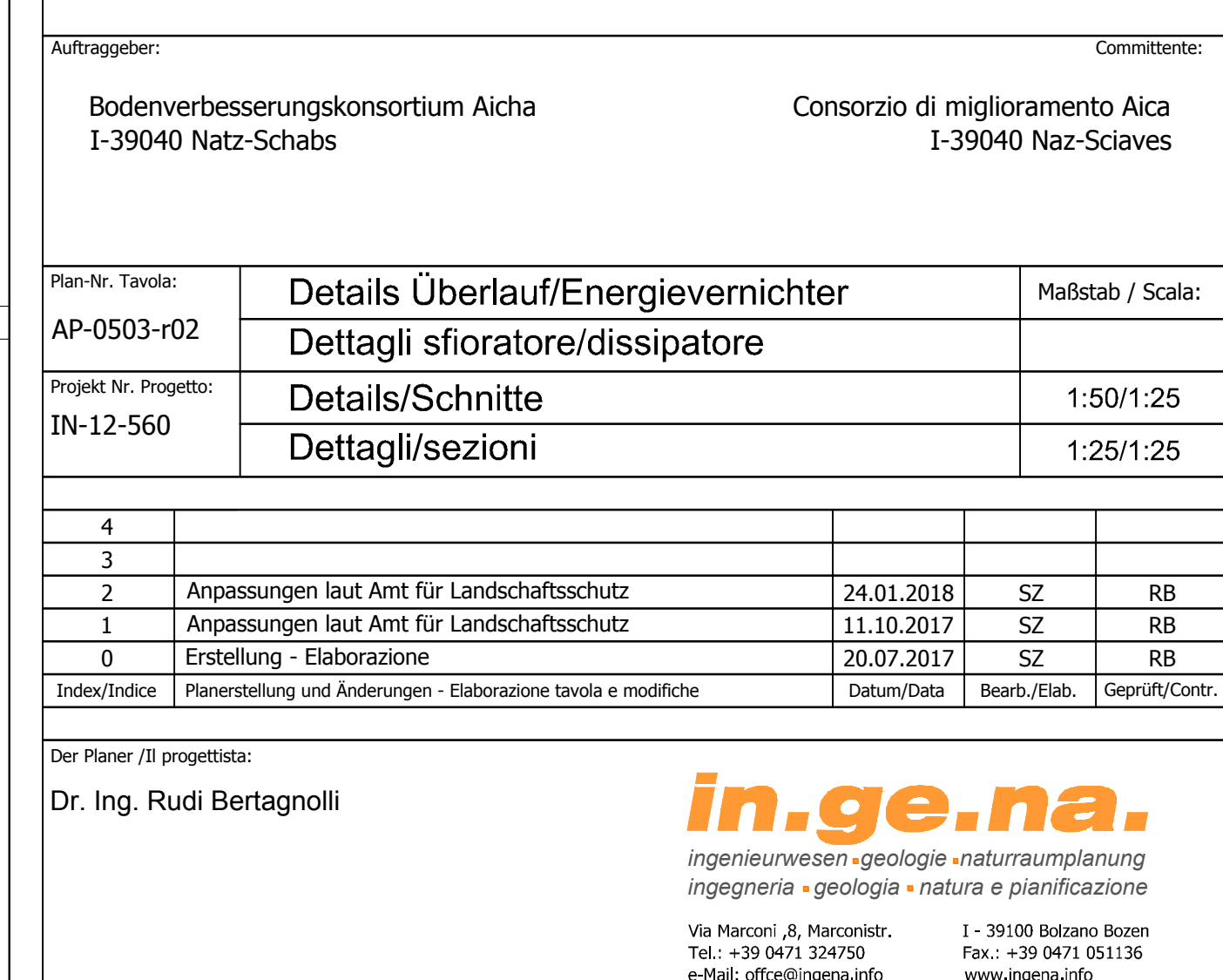
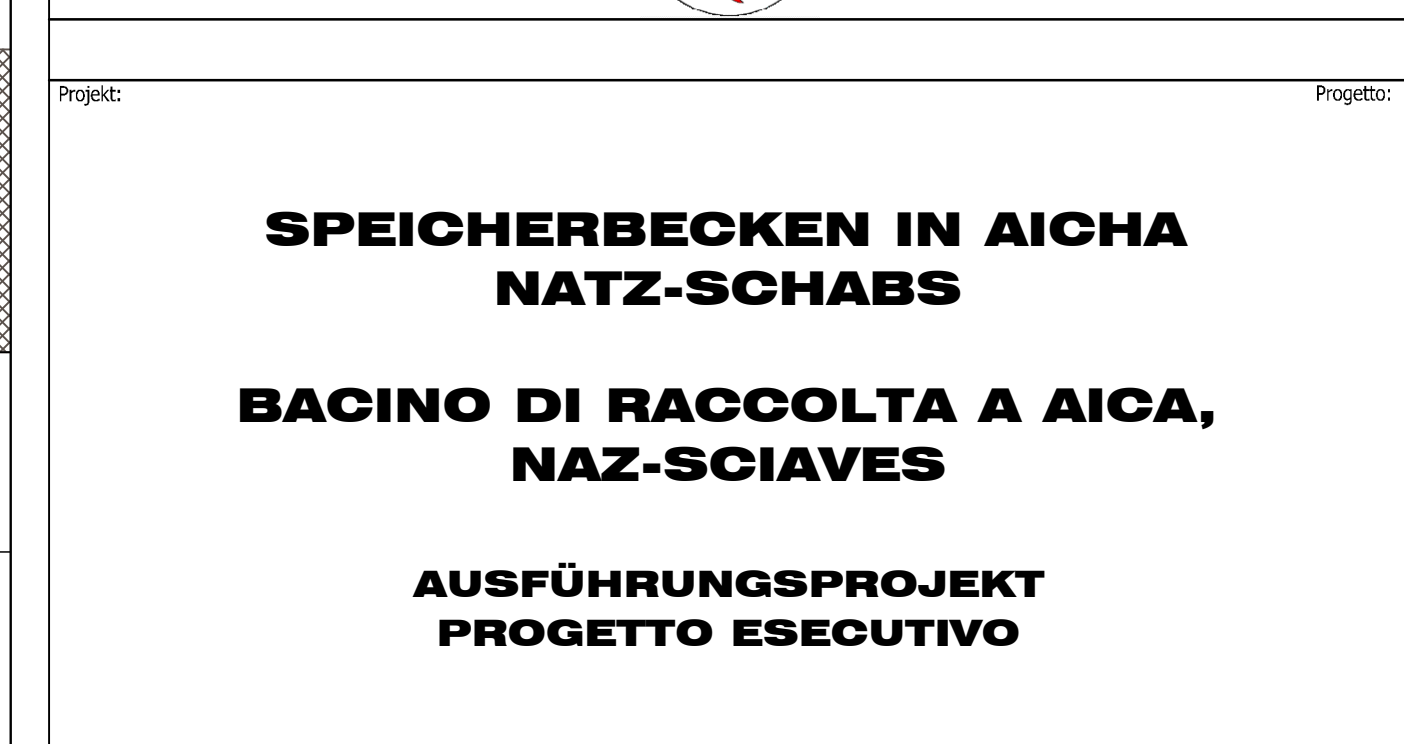
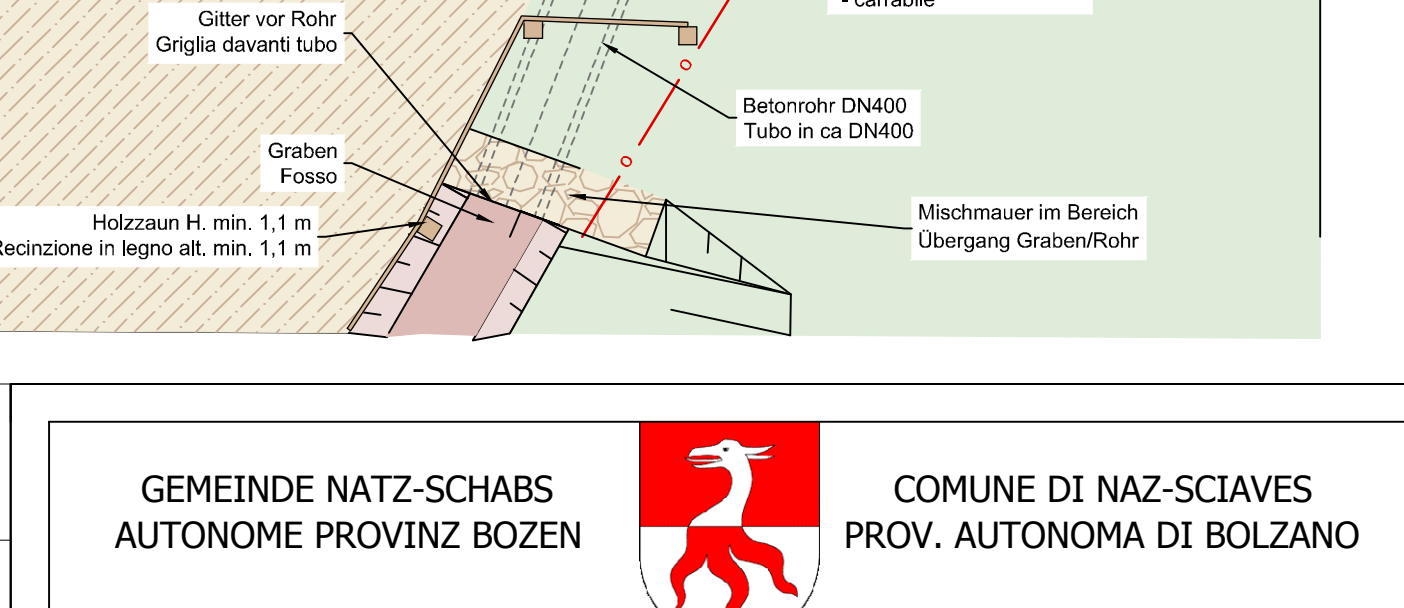
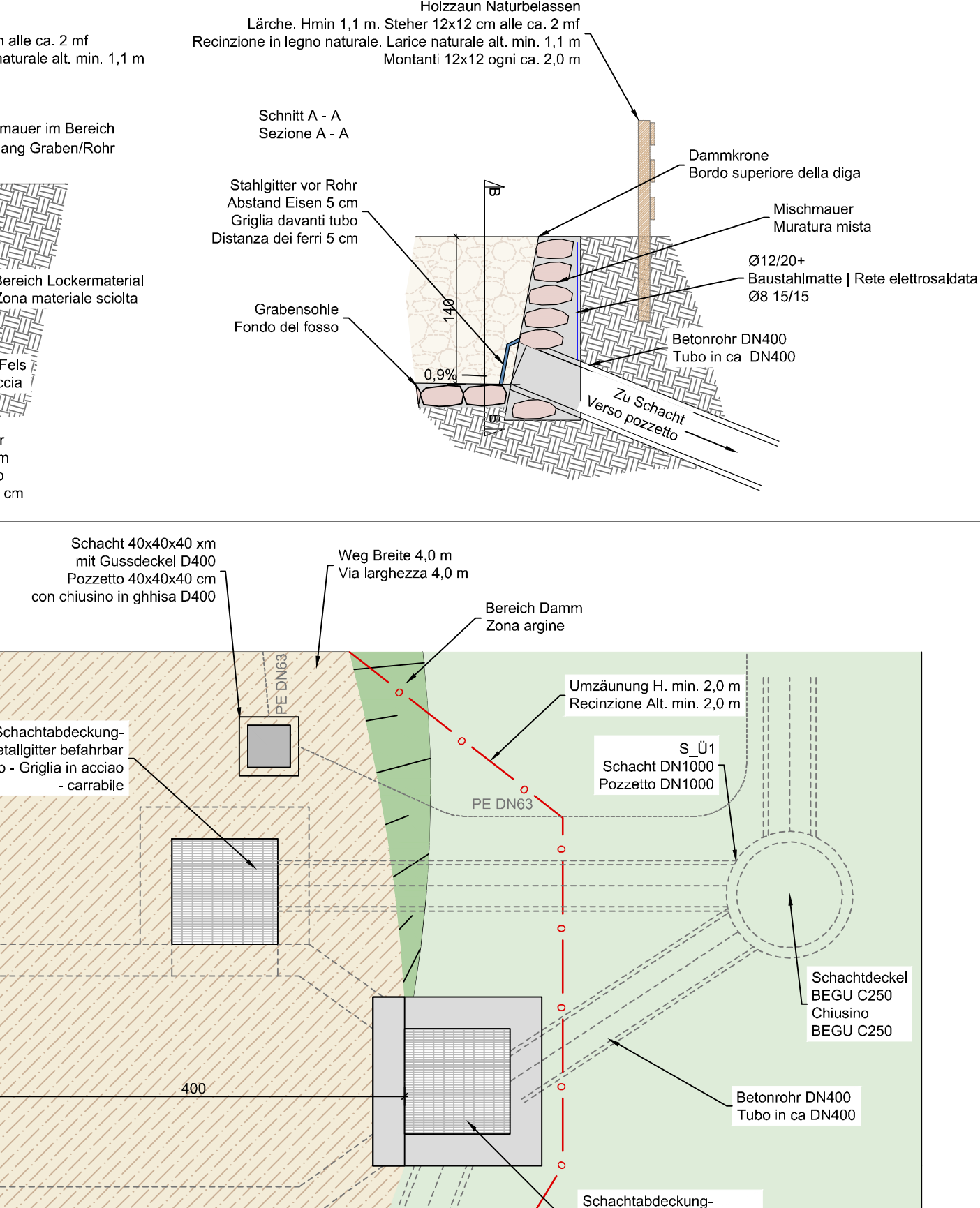

Überlaufbauwerk - Bewehrung 1:50  
Opera di sfiatore - armatura 1:50

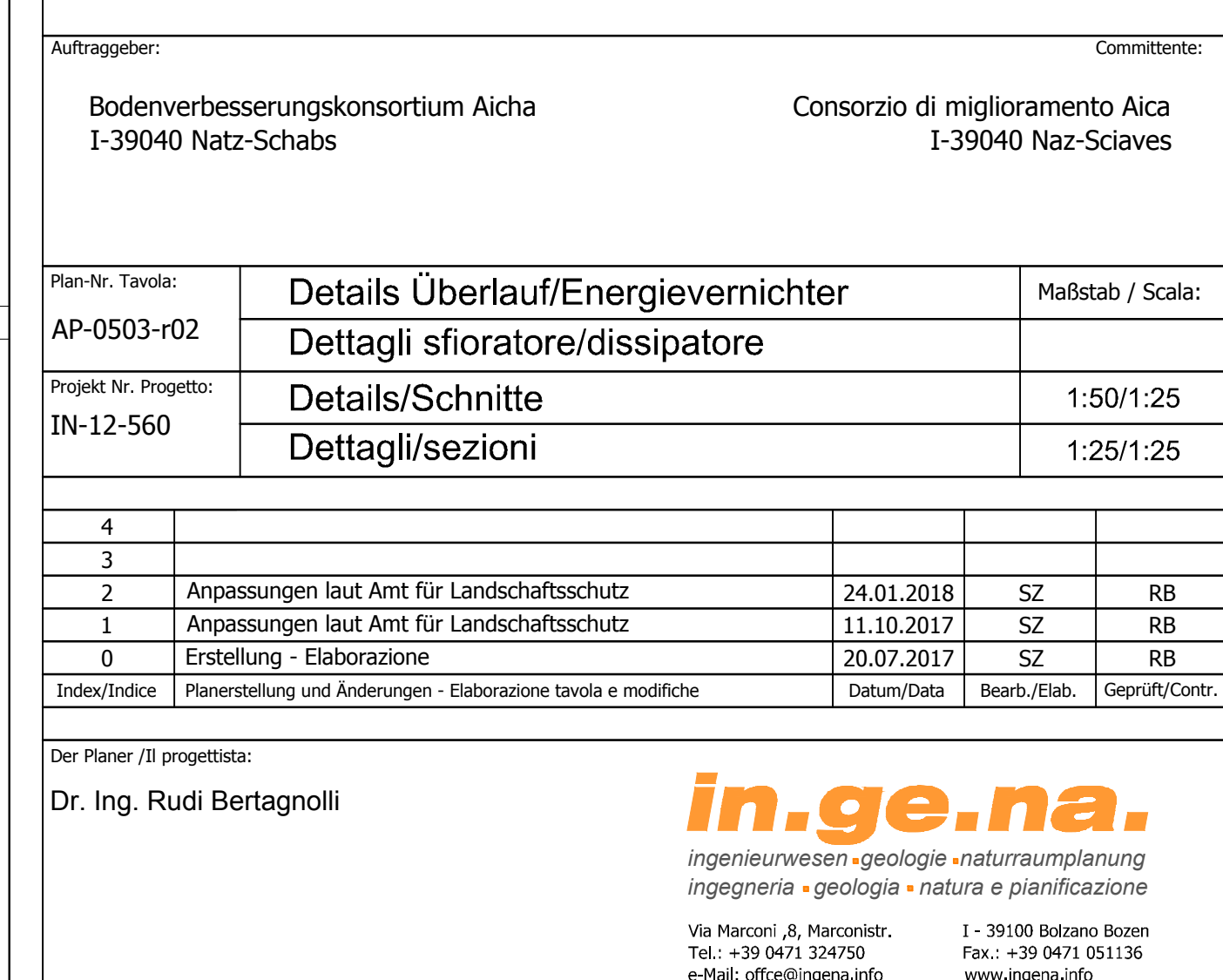
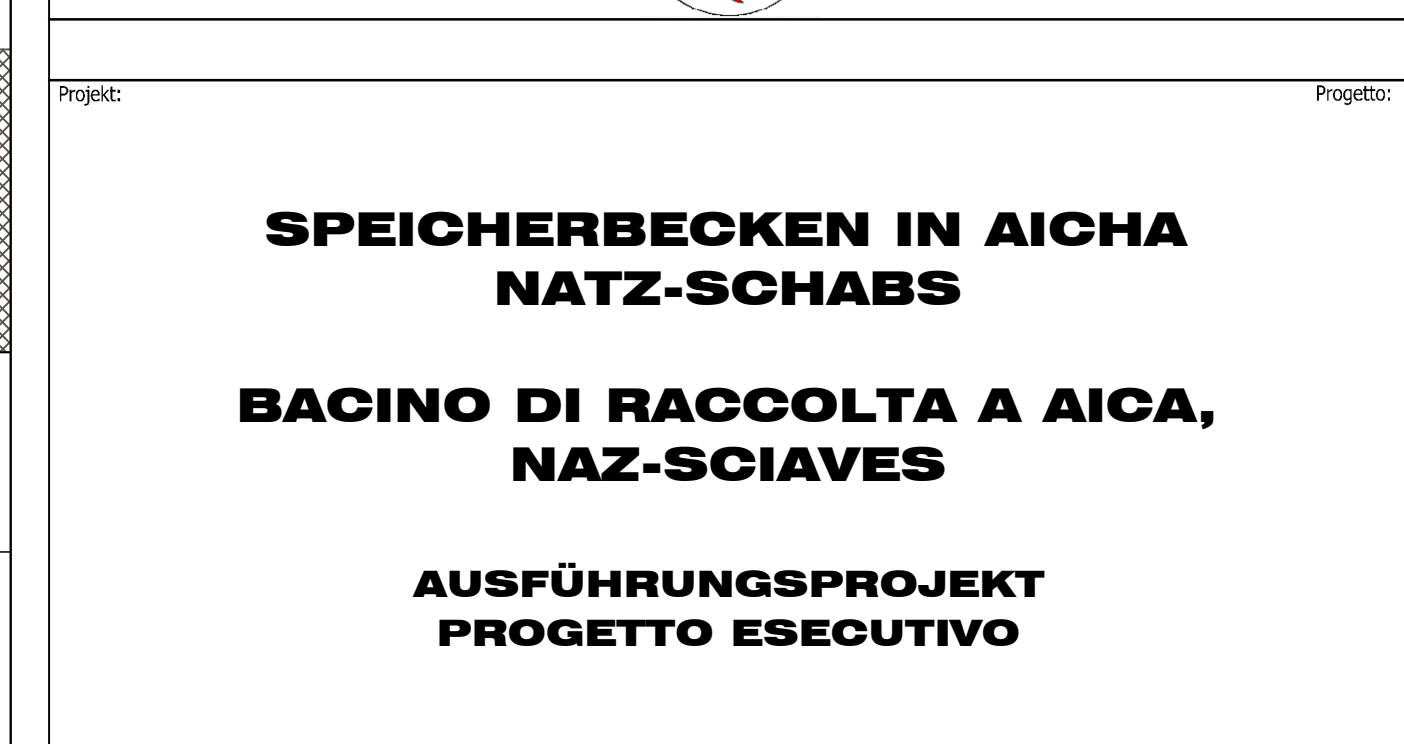
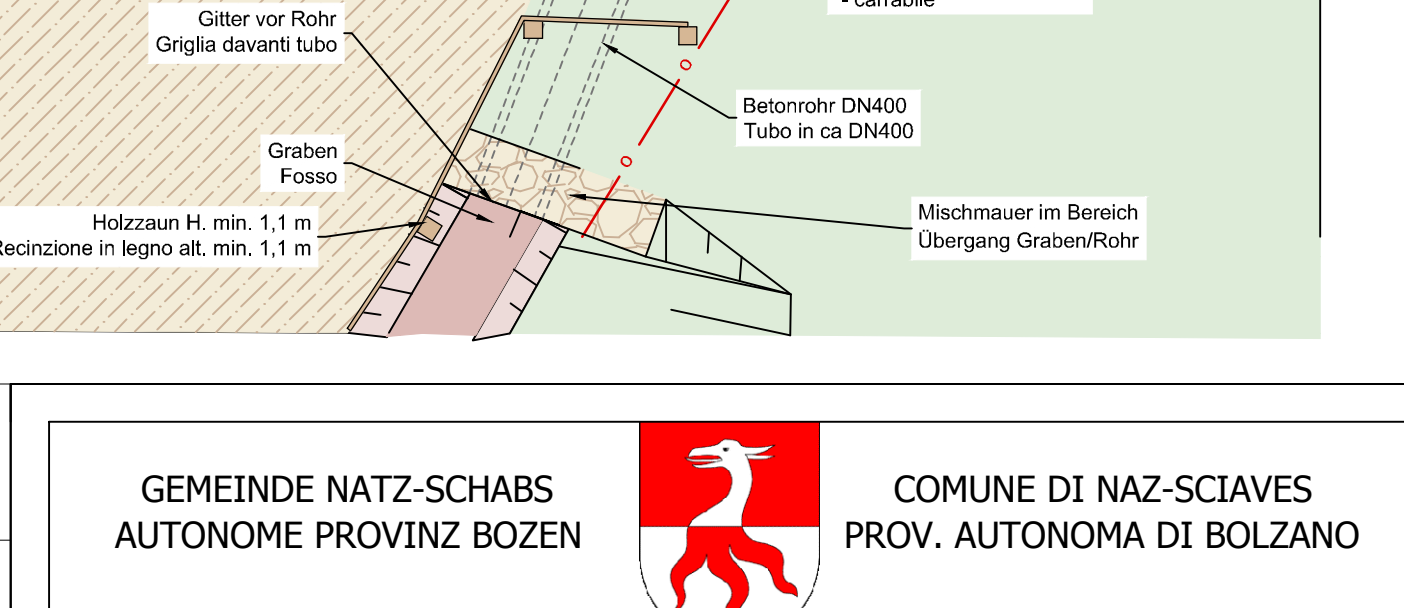
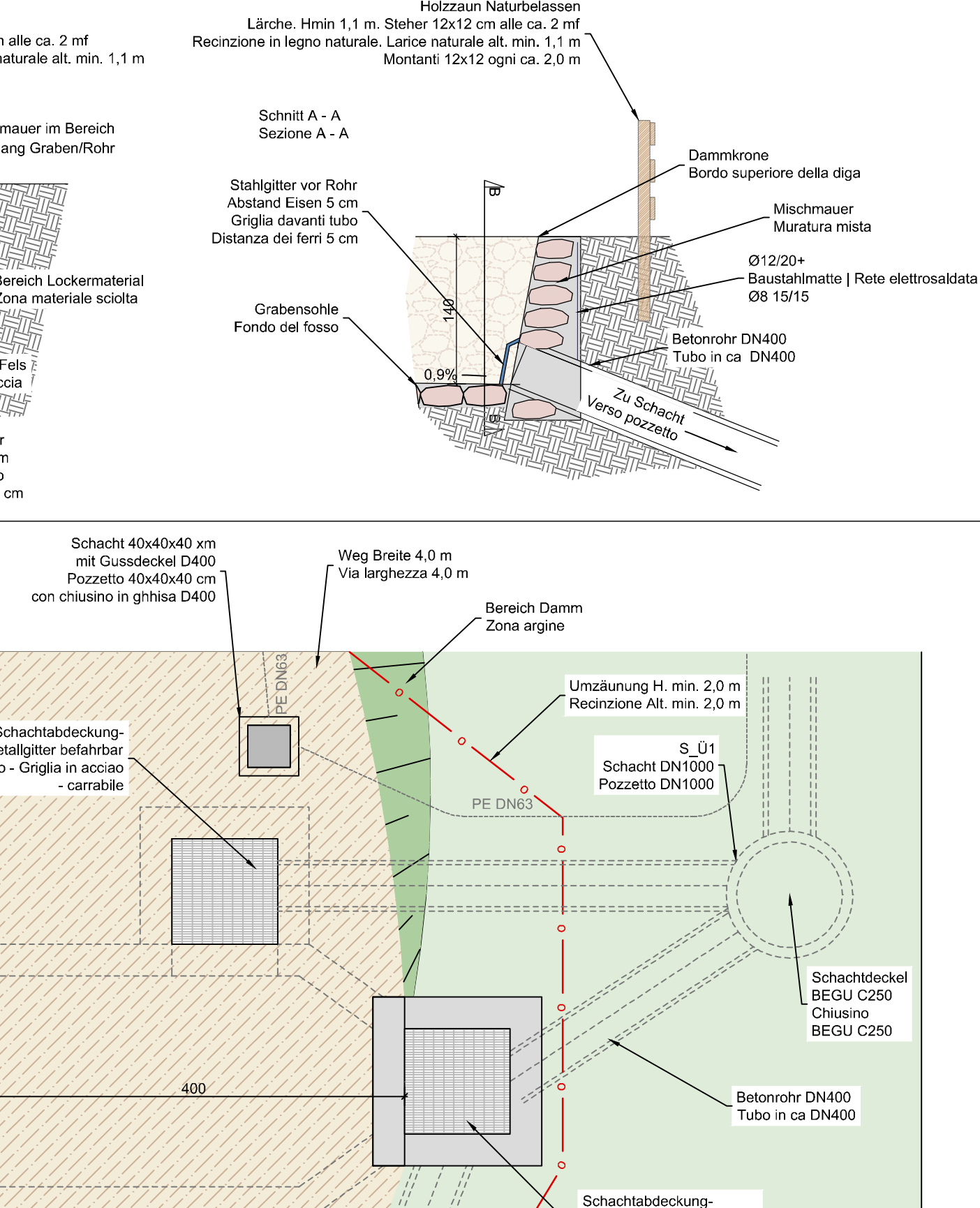

Überlaufbauwerk - Bewehrung 1:50  
Opera di sfiatore - armatura 1:50

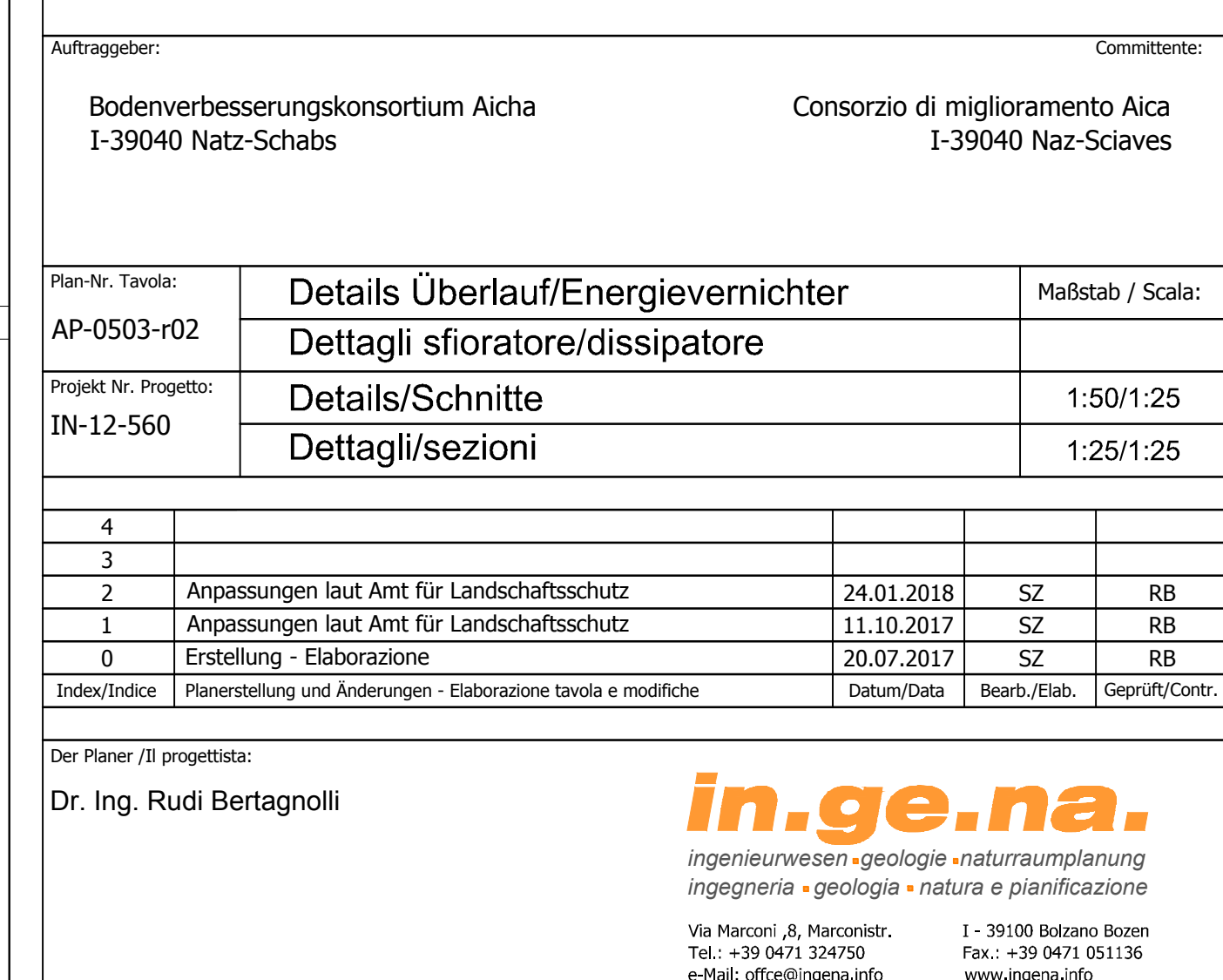
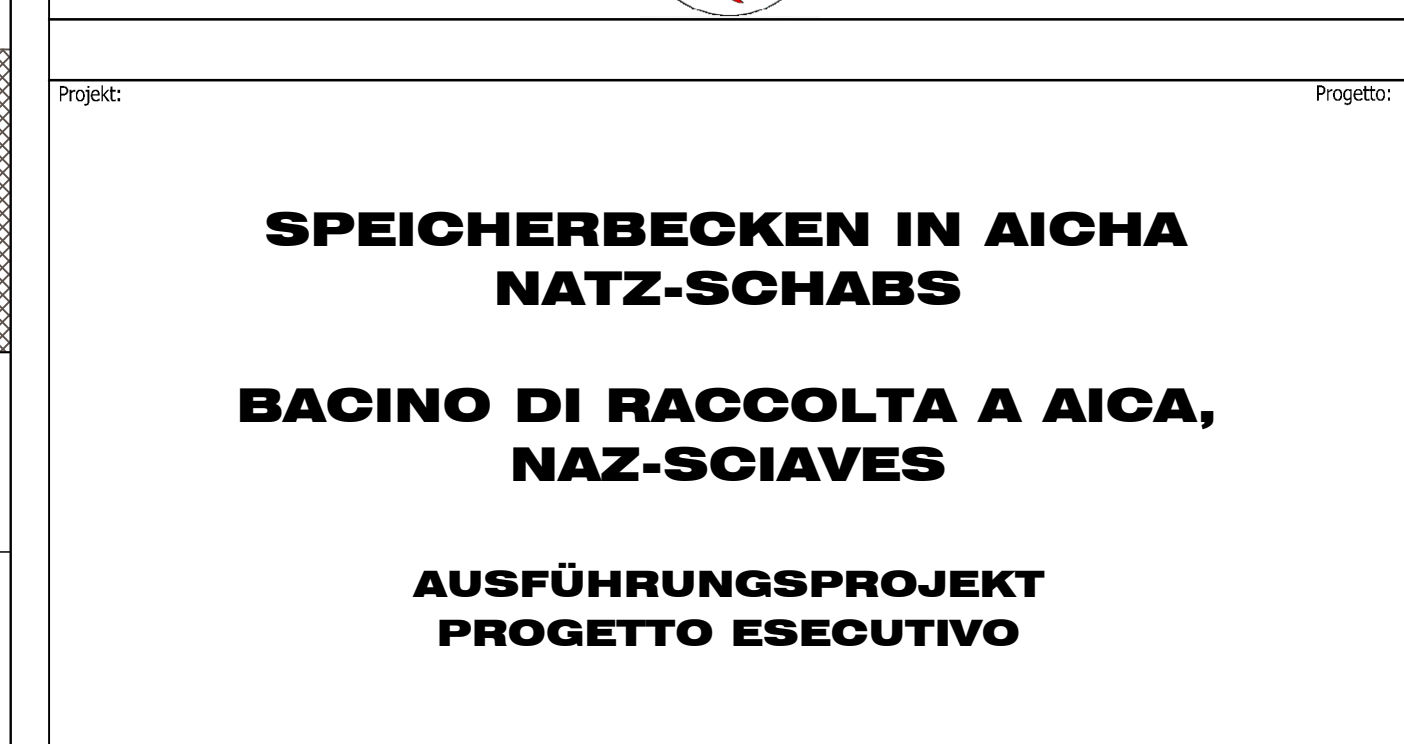
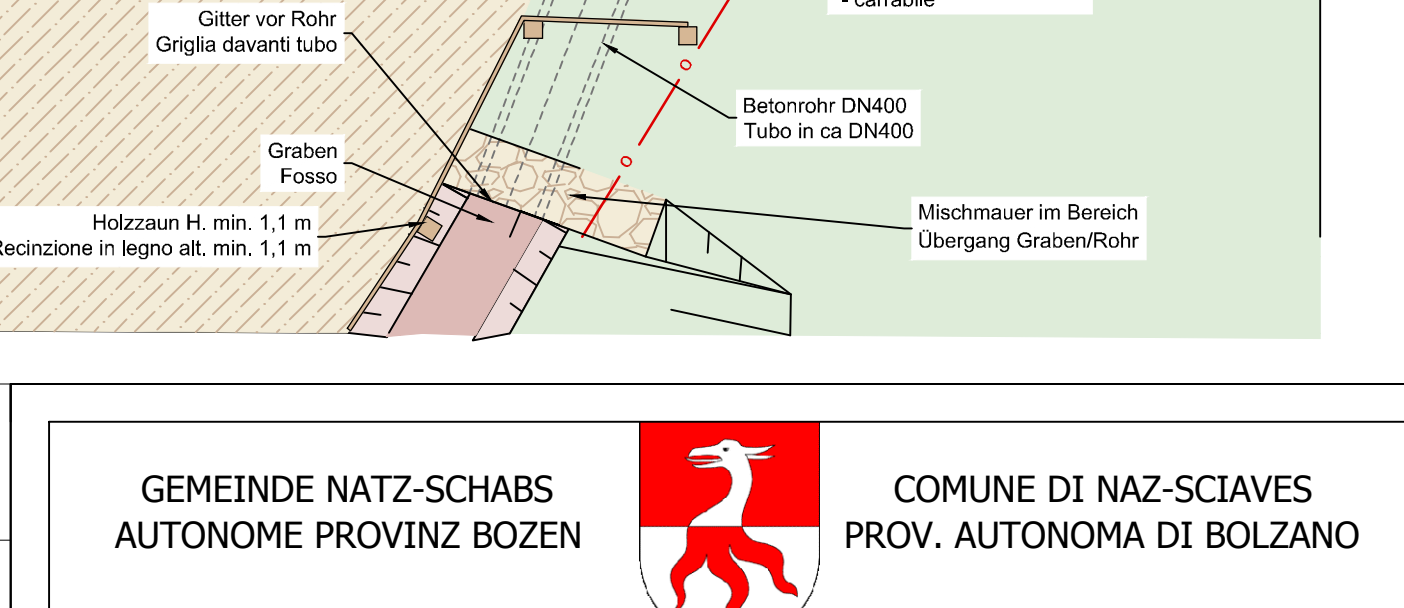
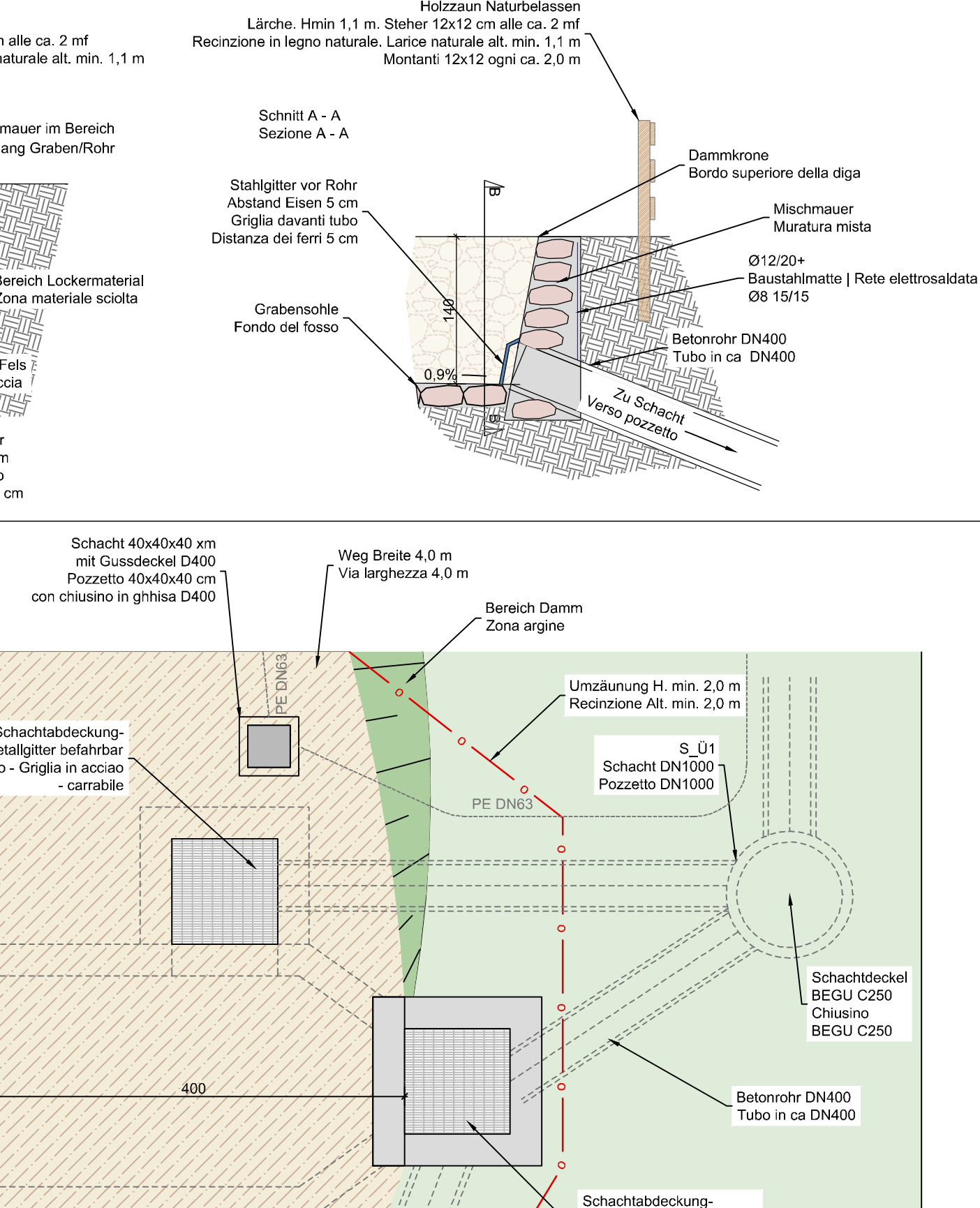

Überlaufbauwerk - Bewehrung 1:50  
Opera di sfiatore - armatura 1:50

